

# INTRINSIX

The power of light  
made easy



# The power of light made easy

Operations at Intrinsic date back to the year 2000. We have a rich history that has led us to becoming a manufacturer of high quality and affordable lighting solutions at the request of our quickly growing customer base. By listening to customer demand, we not only developed trust, but we created genuine relationships with our clients. We have made it part of our company culture to always seek new and valuable ways that we can serve our customers by adding value through saving them money and providing a level of service second to none.

Intrinsic Lighting is a customer focused team driven organization that strives to deliver customer service in a timely manner at a fair price with unmatched customer service. We have a qualified team of experts ready to answer any question you have about our products. We have a smooth warranty process making it easy for you and your customer. Located in the Chicagoland area, we can service a large portion of the country in one business day!

We offer a wide variety of different products to be your one stop shop to better serve you and your customers. We look forward to working with you and being your number one source for lighting fixtures.

In the lighting world there is no argument that people do business with companies they like and trust. Intrinsic instills trust and loyalty among our customers by simply serving them with the right solutions the first time.

## Product Testing

Quality and peace of mind to our customers means everything to us. In order to put our money where our mouth is, we've doubled down to ensure this.

Our unique testing approach rapidly replicates over 10 years of real world use in a mere few weeks.

We simulate arctic grade temperatures and scorching desert heat and extreme levels of humidity over and over again. Our testing process allows us to learn from real results and not just rely on what we know from the same first year performance metrics.

We know our products are quality because we test them up front. We know how they will perform day in and day out no matter what is thrown at them.

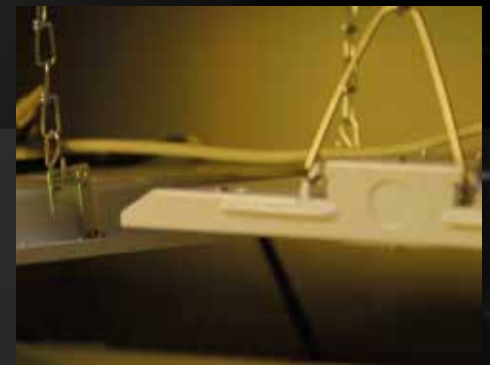

# XPEDITE Parcel

The 'Xpedite Parcel' program provides you with lighting and control products from IntrinsicX, a leading brand in performance, reliability and quality. We are geared to provide the lighting you need, when and where you want it, eliminating hold ups on your scheduling.

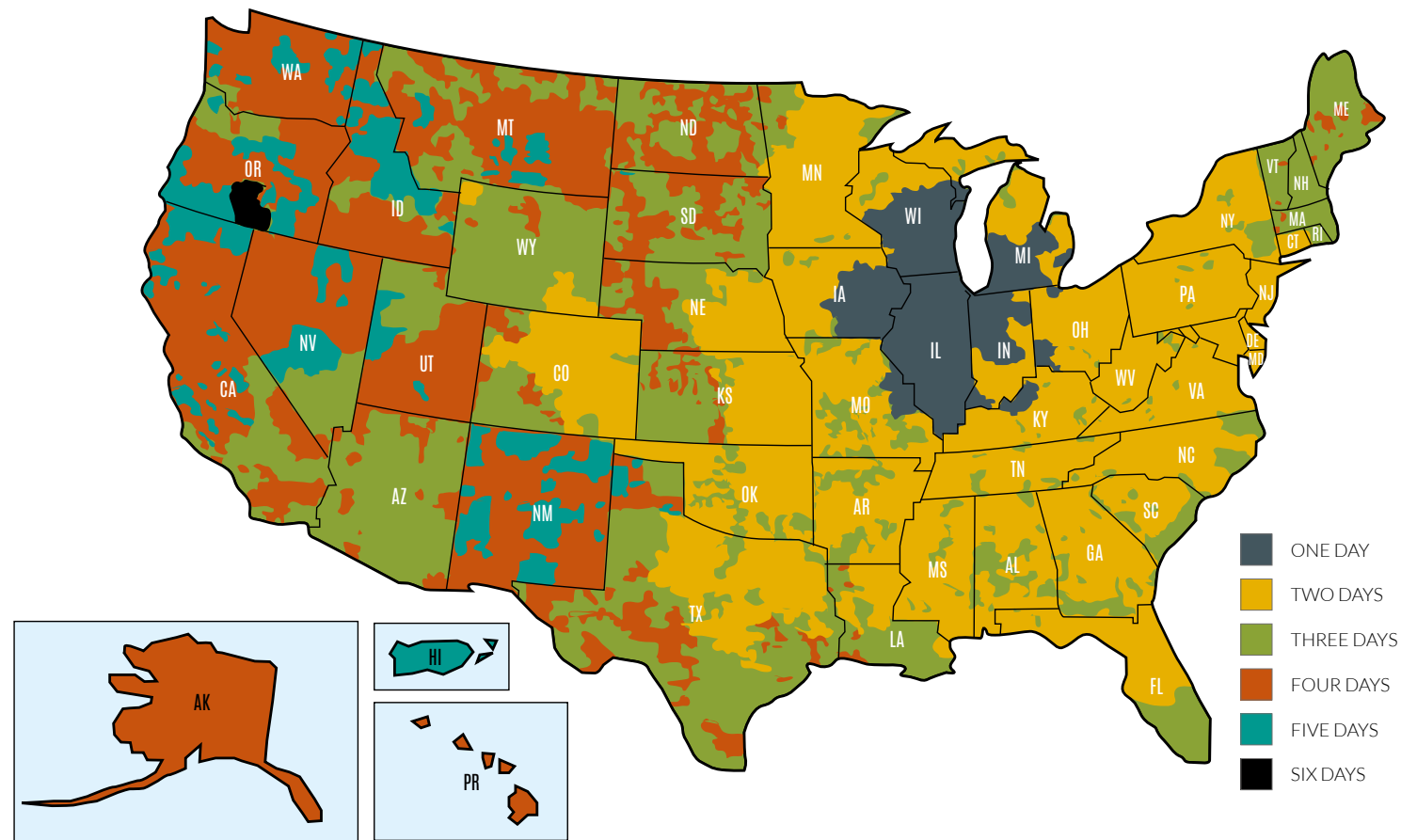

# XPEDITE LTL

The 'Xpedite LTL' program provides you with lighting and control products from IntrinsicX, a leading brand in performance, reliability and quality. We are geared to provide the lighting you need, when and where you want it, eliminating hold ups on your scheduling.

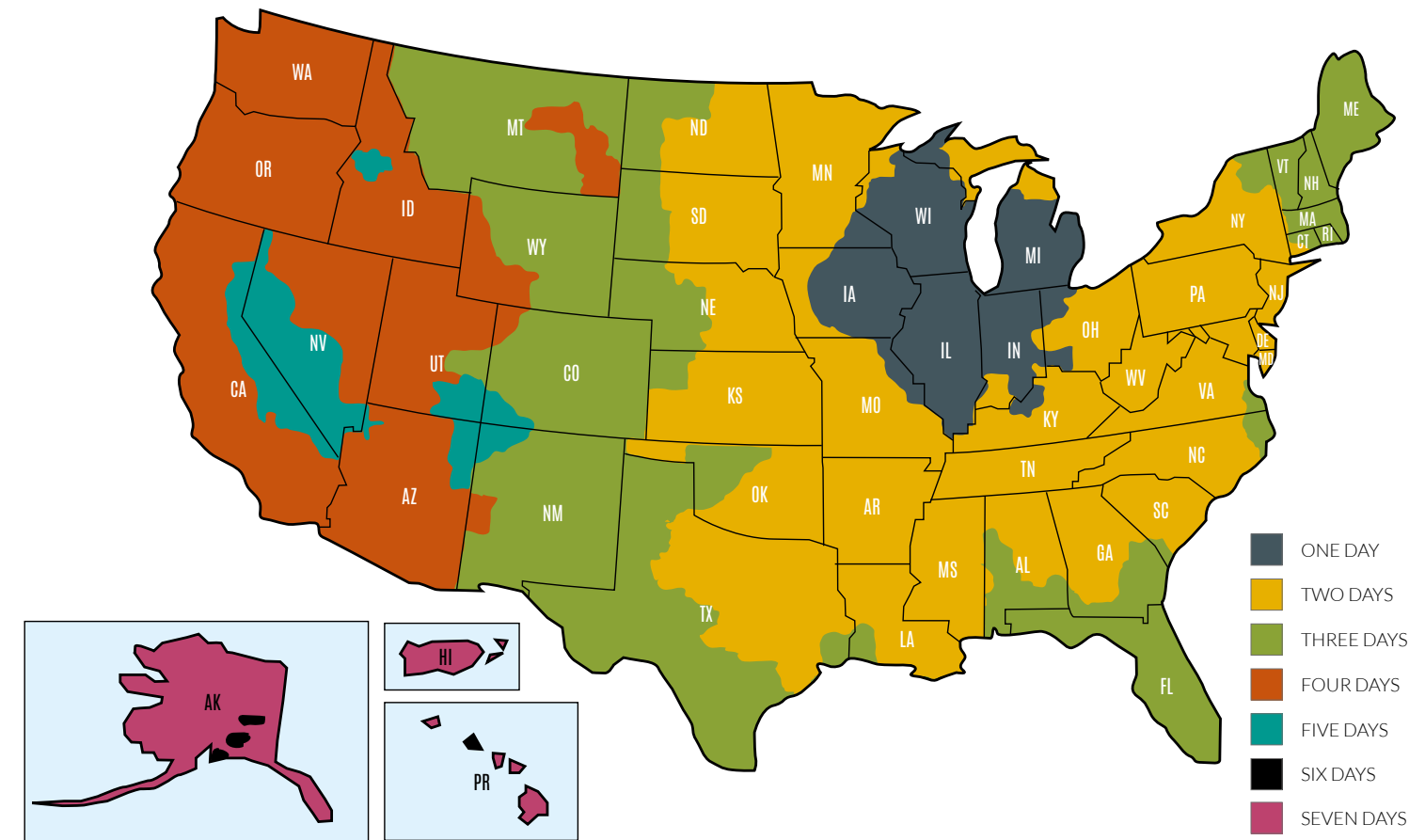

**INTRINSIX  
WARRANTY**

Five years/  
50,000 Hrs



**FREE  
FREIGHT**

no charge for freight  
on orders under 4ft.



**RAPID  
RESPONSE**

with our dedicated  
service team



**SCHEDULED  
SHIPPING**

we get it to you  
when you need it



**24  
HOUR  
WARRANTY  
RESOLUTION**

for your total  
peace of mind



**INTRINSIX  
WARRANTY**

Five years/  
50,000 Hrs



**FREE  
FREIGHT**

no charge for freight  
on orders under 4ft.



**RAPID  
RESPONSE**

with our dedicated  
service team



**SCHEDULED  
SHIPPING**

we get it to you  
when you need it



**24  
HOUR  
WARRANTY  
RESOLUTION**

for your total  
peace of mind



Retrofit lighting | 7-9



Speciality lighting | 10-16



Interior | 17-29



Exit & Emergency | 30-32



Exterior | 33-45



Accessories | 46-49

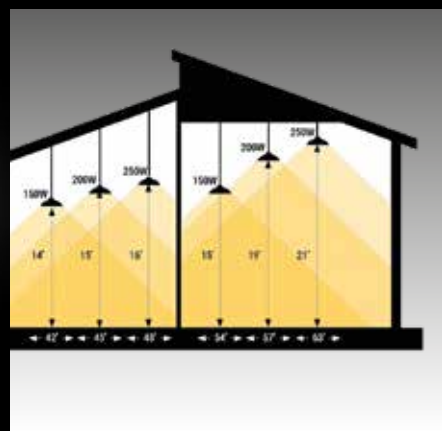

Helpful Hints | 50-51

# COSMOS

## MAG STRIP RETROFIT

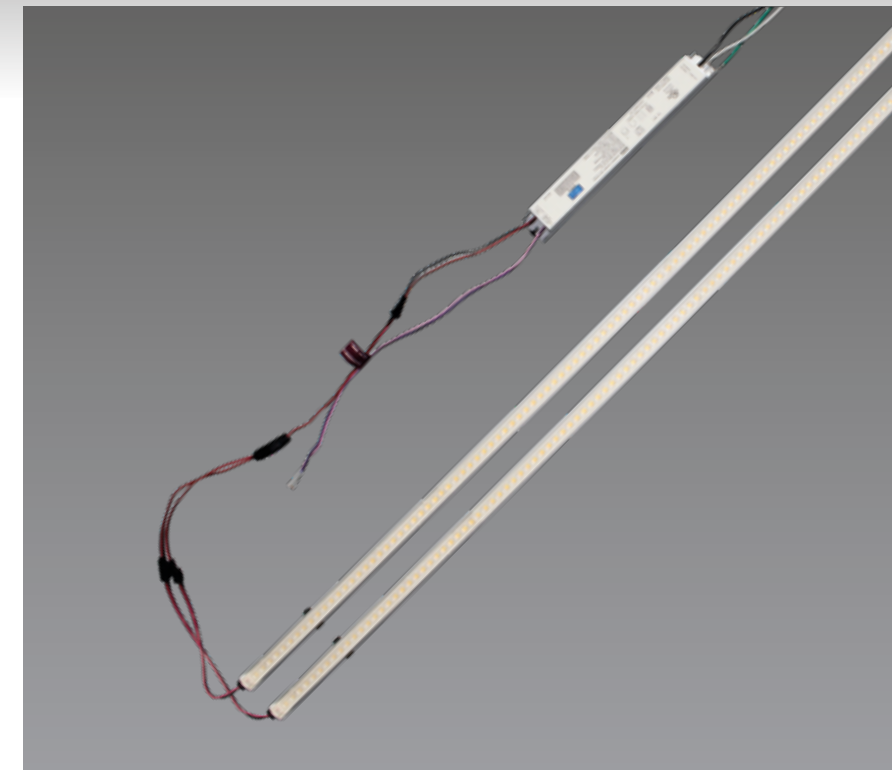

### Description

The INTRINSIX COSMOS LED retrofit are highly versatile and can be used with various fixture types.

They are compatible with linear lighting fixtures, troffers, and other similar configurations.

The COSMOS uses on average 50% less energy than traditional fluorescent, incandescent, and halogen lights. This saving in energy equates to a small energy bill. Also, the COSMOS LED strip lasts at least 50,000 hours, and our 5 years/50,000 hour warranty guarantees it.

### Specifications

- Temperature: 4000K or 5000K
- Dimming: 0-10V
- Voltage: 120-277V
- Operating Temp: -4°F to 113°F
- Efficacy: 130Lm/W
- Power Factor: >0.90
- DLC Listing: Premium
- Warranty: 50,000 Hours/5 Years



Driver 24W 1 Strip   Driver 30W 1 Strip   Driver 40W 2 Strips   Driver 60W 3 Strips   Driver 60W 4 Strips   Driver 80W 4 Strips

### Retrofit Strip Fixture Details

Model Number	Fixture Length	No. of Strips	Power (Watts)	Voltage (V)	CCT (K)	CRI Cover F = Frosted O = Optical	Dimming (Volts)	Efficacy (Lm/W)	Operating Temperature	DLC Code 4000K/5000K
IX-RTST-124	2'	1	24	120-277	4000-5000	F / O	0-10	130	-4°F-113°F	S-PY3FN7/ S-HOISU5
IX-RTST-2- 230	2'	2	30	120-277	4000-5000	F / O	0-10	130	-4°F-113°F	S-8VDOJ2/ S-6QBKRM
IX-RTST-230	4'	2	30	120-277	4000-5000	F / O	0-10	130	-4°F-113°F	S-KH4FYJ/S-IEAC0W
IX-RTST-240	4'	2	40	120-277	4000-5000	F / O	0-10	130	-4°F-113°F	S-KH4FYJ/S-IEAC0W
IX-RTST-248	4'	2	48	120-277	4000-5000	F / O	0-10	130	-4°F-113°F	S-8VDOJ2/ S-6QBKRM
IX-RTST-360	4'	3	60	120-277	4000-5000	F / O	0-10	130	-4°F-113°F	TBA
IX-RTST-460	4'	4	60	120-277	4000-5000	F / O	0-10	130	-4°F-113°F	TBA
IX-RTST-480	4'	4	80	120-277	4000-5000	F / O	0-10	130	-4°F-113°F	S-ZHR406/S-DW1T8Q

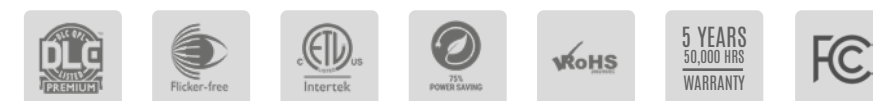

# ASTRAL

## LED TROFFER RETROFIT

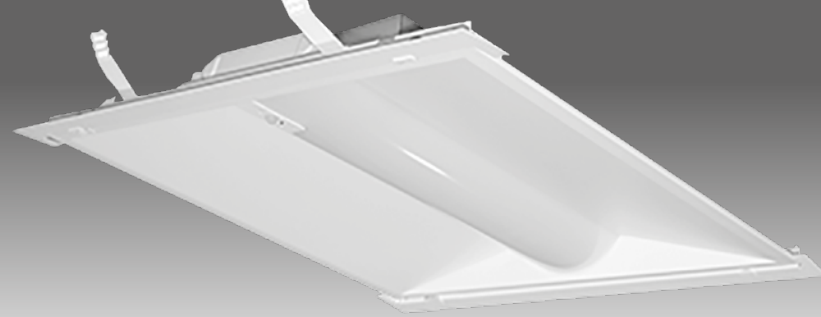

### Description

With an integrated PIR Sensor, the Intrinsic ASTRAL LED Troffer Retrofit offers options for Bluetooth mesh system or occupancy, with both having daylight harvesting.

The Intrinsic ASTRAL allows for easy installation using existing housing of most 2'x4' or 2'x2' fixtures.

With the two different integrated sensor (Bluetooth NLC or Occupancy PIR), you are saving money with an upgrade of existing instead of changing the whole fixture.

### Specifications

- CCT: 3500K/4000K/5000K
- Dimming: 0-10V
- Voltage: 120-277V
- Efficacy: 130Lm/W
- Operating temp: -4°F to 122°F
- IP Rating: IP20
- Power factor: <0.90
- Warranty: 50,000 Hours/5 years

### Retrofit Troffer Fixture Details

Product Number	Size	Watts (Selectable)	CCT(K) (Selectable)	CRI	Efficacy (Lm/W)	Lumen Output Temperature (Lm)	Operating Temperature	IP	Bluetooth Mesh Capable	DLC Code
IX-TRS-NLC-22-24/36-35/40/50LO	2' x 2'	24/30/36	3500/4000/5000	>83	130	3120/4680	-4°F to 122°F	IP20	Yes	S-BYJAUS
IX-TRS-NLC-24-36/42/50-35/40/50LO	2' x 4'	24/36/45	3500/4000/5000	>83	130	4680/5460/6500	-4°F to 122°F	IP20	Yes	S-G75PBL
IX-TRS-PIR-22-24/36-35/40/50LO	2' x 2'	24/30/36	3500/4000/5000	>83	130	3120/4680	-4°F to 122°F	IP20	No	S-E7LJMP
IX-TRS-PIR-24-36/42/50-35/40/50LO	2' x 4'	24/36/45	3500/4000/5000	>83	130	4680/5460/6500	-4°F to 122°F	IP20	No	S-X8PG9R

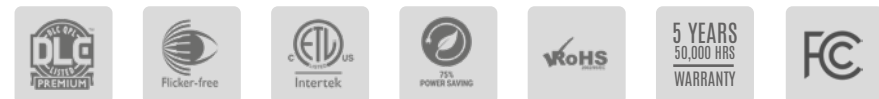

# SOFCAN

## CANOPY RETROFIT

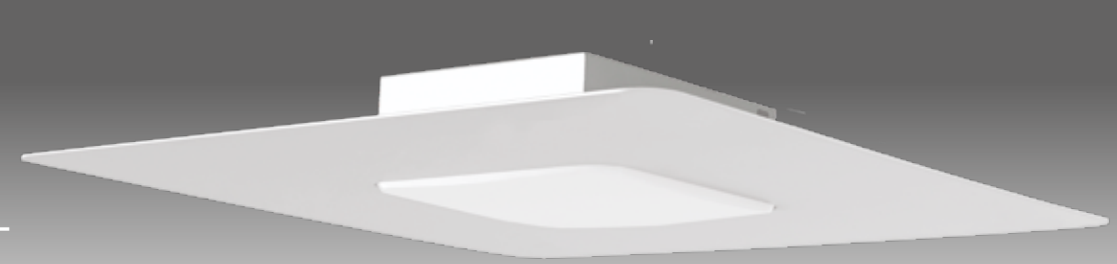

### Description

Intrinsic's SOFCAN Canopy Retrofit is the perfect choice when considering retrofitting your existing canopy soffits as well as many other canopy applications such as drive-throughs, loading docks and store fronts.

This unique system comes wattage selectable (20W/30W/40W) allowing for user friendly operation. Multiple beauty plate options to make for a smooth and seamless retrofit.

### Specifications

- Beauty Plates: 12"/15"/18"/24"
- Color: 5000K
- Voltage: 120V to 277V
- Efficiency: 140Lm/W
- IP Rating: IP65
- Lens: Frosted Lens
- Warranty: 50,000 Hours/5 Years

### Retrofit Canopy Fixture Details

Product Number	Power (W)	CCT (K)	Efficacy (Lm/W)	CRI	Lumen Output Temperature (Lm)	Operating Temperature	IP Rating	DLC Product ID
IX-SCR-20/30/40-50LO	20/30/40	5000	140	80+	2800/4200/5600	-4°F to 131°F	IP65	P2MWBSLL

SELECTABLE WATTAGE



### Beauty Plate Options

Wrap Product Number	Size
IX-SCR-12WBP	12"x12"
IX-SCR-15WBP	15"x15"
IX-SCR-18WBP	18"x18"
IX-SCR-24WBP	24"x24"



# HAZA L1:1

LINEAR LED CLASS 1 DIVISION 1



## Description

Linear LED ceiling mounted light designed specifically for hazardous locations in warehouses, factories and workshops, petroleum and petrochemical areas, gas stations, power stations, railways, shipping ports, public security areas, fire protection and other fields.

Separated, the LED board and driver makes higher heat resistance and better heat dissipation.

## Specifications

- Mounting: Trunnion Mount, Pendant, Hook
- Accessories: Wire Guard
- Voltage: 120-277VAC
- Wattage: 40W, 80W, 120W
- Lumen Output: 5,400 - 16,200lm
- Efficacy: 135Lm/W
- Color Rendering: >70
- Color Temp: 5000K
- Lens: Clear glass
- Power Factor: >0.9
- THD: ≤20%
- Housing Color: Gray
- Operating Temp: -40°F to 149°F



## Fixture Details

Product Number	Watts (W)	Voltage (V)	CRI	Efficacy (Lm/W)	CCT (K)	Lumen Output (Lm)	Operating Temperature
IX-HAZA-LX-1-1-40LO	40	120-277	>70	135	5000	5400	-40°F to 149°F
IX-HAZA-LX-1-1-80LO	80	120-277	>70	135	5000	10800	-40°F to 149°F
IX-HAZA-LX-1-1-120LO	120	120-277	>70	135	5000	16200	-40°F to 149°F



# HAZA R1:1

ROUND LED CLASS 1 DIVISION 1



## Description

LED ceiling or wall mounted round light designed specifically for hazardous locations in warehouses, factories and workshops, petroleum and petrochemical areas, gas stations, power stations, railways, shipping ports, public security areas, fire protection and other fields. Separated LED board and driver makes higher heat resistance and better heat dissipation.

The wiring cavity helps to isolate the LED board and the driver so as to make wiring safer. The wire guard prevents the glass from being broken.

## Specifications

- Mounting: Trunnion Bracket, Pole mount
- Accessories: Flat Wire Guard, Wire Guard, U-Shaped Wire Guard
- Voltage: 120-277VAC
- Wattage: 30W, 60W, 100W, 150W
- Lumen Output: 4,140 - 20,700lm
- Efficacy: 138Lm/W
- Color Rendering: >80
- Color Temp (K): 5000K
- Lens: Clear Glass, Clear Striped Spherical Glass, U-Shaped Glass
- Beam Angle: 80°, 110°, 120°
- Power Factor: >0.9
- THD: ≤20%
- Housing Color: Gray
- Operating Temp: -40°F to 131°F



## Fixture Details

Product Number	Watts (W)	Voltage (V)	CRI	Efficacy (Lm/W)	CCT (K)	Lumen Output (Lm)	Operating Temperature
IX-HAZA - R1-1-30LO	30	120-240, 120-277	>80	138	5000	4140	-40°F to 131°F
IX-HAZA - R1-1-60LO	60	120-240, 120-277	>80	138	5000	8280	-40°F to 131°F
IX-HAZA - R1-1-100LO	100	120-240, 120-277	>80	138	5000	13800	-40°F to 131°F
IX-HAZA - R1-1-150LO	150	120-240, 120-277	>80	138	5000	20700	-40°F to 131°F



SPECIALTY

SPECIALTY

# HAZA S1:1

SQUARE LED CLASS 1 DIVISION 1



## Description

LED ceiling, floor or wall mounted square light designed specifically for hazardous locations in warehouses, factories and workshops, petroleum and petrochemical areas, gas stations, power stations, railways, shipping ports, public security areas, fire protection and other fields.

Separated, the LED board and driver makes higher heat resistance and better heat dissipation. The wiring cavity helps to isolate the LED board and the driver making wiring safer. The wire guard prevents the glass from being broken.

## Specifications

- Mounting: Slip Fitter, Universal Bracket, Direct Mounting Bracket, Trunnion Mount
- Accessories: Shield, Wire Guard
- Voltage: 120-277VAC
- Wattage: 30, 60, 100, 150, 200
- Lumen Output: 4,050 – 26,000lm
- Efficacy: 130-135Lm/W
- Color Rendering: >70
- Color Temp (K): 5000K
- Lens: Clear glass
- Power Factor: >0.9
- THD: ≤20%
- Housing Color: Gray
- Operating Temp: -40°F to 131°F



## Fixture Details

Product Number	Watts (W)	Voltage (V)	CRI	Efficacy (Lm/W)	CCT (K)	Lumen Output (Lm)	Operating Temperature
IX-HAZA-S1-1-30LO	30	120-277	>70	135	5000	4050	-40°F to 131°F
IX-HAZA-S1-1-60LO	60	120-277	>70	130	5000	7800	-40°F to 131°F
X-HAZA-S1-1-100LO	100	120-277	>70	130	5000	13000	-40°F to 131°F
IX-HAZA-S1-1-150LO	150	120-277	>70	130	5000	19500	-40°F to 131°F
IX-HAZA-S1-1-200LO	200	120-277	>70	130	5000	26000	-40°F to 131°F



# HAZA L1:2

LINEAR LED CLASS 1 DIVISION 2



## Description

Linear LED ceiling mounted light designed specifically for hazardous locations in warehouses, factories and workshops, petroleum and petrochemical areas, gas stations, power stations, railways, shipping ports, public security areas, fire protection and other fields.

Separated, the LED board and driver makes higher heat resistance and better heat dissipation.

## Specifications

- Mounting: Trunnion Mount, Pendant, Hook
- Accessories: Wire Guard
- Voltage: 120-277VAC
- Wattage: 40W, 80W, 120W
- Lumen Output: 5,000 - 16,200lm
- Efficacy: 135Lm/W
- Color Rendering: >70 / >80
- Color Temp: 5000K
- Lens: Clear glass
- Power Factor: >0.9
- THD: ≤20%
- Housing Color: Gray
- Operating Temp: -40°F to 149°F



## Fixture Details

Product Number	Watts (W)	Voltage (V)	CRI	Efficacy (Lm/W)	CCT (K)	Lumen Output (Lm)	Operating Temperature
IX-HAZA-LX-1-2-40LO	40	120-277	>70	135	5000	5400	-40°F to 149°F
IX-HAZA-LX-1-2-80LO	80	120-277	>70	135	5000	10800	-40°F to 149°F
IX-HAZA-LX-1-2-120LO	120	120-277	>70	135	5000	16200	-40°F to 149°F



# HAZA R1:2

ROUND LED CLASS 1 DIVISION 2



## Description

LED ceiling, wall or floor mounted round light designed specifically for hazardous locations in warehouses, factories and workshops, petroleum and petrochemical areas, gas stations, power stations, railways, shipping ports, public security areas, fire protection and other fields. Separated, the LED board and driver makes higher heat resistance and better heat dissipation. The wiring cavity, helps to isolate the operator and the driver so as to make wiring safer. The wire guard prevents the glass from being broken.

## Specifications

- Mounting: Trunnion Bracket, Pole Mounted
- Accessories: Flat Wire Guard, Wire Guard, U-Shaped Wire Guard
- Voltage: 120-277VAC
- Wattage: 30W, 60W, 100W, 150W, 200W, 240W, 300W, 400W
- Lumen Output: 4,050 - 58,800lm
- Efficacy: 130-155Lm/W
- Color Rendering: >80
- Color Temp (K): 5000K
- Lens: Clear Glass, Clear Striped Spherical Glass, U-Shaped Glass,
- Power Factor: >0.9
- THD: ≤20%
- Housing Color: Gray
- Operating Temp: -40°F to 131°F



## Fixture Details

Product Number	Watts (W)	Voltage (V)	CRI	Efficacy (Lm/W)	CCT (K)	Lumen Output (Lm)	Operating Temperature
IX-HAZA - R1-2-30LO	30	120-277	>80	135	5000	4050	-40°F to 131°F
IX-HAZA - R1-2-60LO	60	120-277	>80	130	5000	7800	-40°F to 131°F
IX-HAZA - R1-2-100LO	100	120-277	>80	140	5000	14000	-40°F to 131°F
IX-HAZA - R1-2-150LO	150	120-277	>80	140	5000	21000	-40°F to 131°F
IX-HAZA - R1-2-200LO	200	120-277	>80	147	5000	29400	-40°F to 131°F
IX-HAZA - R1-2-240LO	240	120-277	>80	147	5000	35280	-40°F to 131°F
IX-HAZA - R1-2-300LO	300	120-277	>80	147	5000	44100	-40°F to 131°F
IX-HAZA - R1-2-400LO	400	120-277	>80	147	5000	58800	-40°F to 131°F



# HAZA S1:2

SQUARE LED CLASS 1 DIVISION 2



## Description

LED ceiling, floor or wall mounted square light designed specifically for hazardous locations in warehouses, factories and workshops, petroleum and petrochemical areas, gas stations, power stations, railways, shipping ports, public security areas, fire protection and other fields. Separated, the LED board and driver makes higher heat resistance and better heat dissipation. The wiring cavity helps to isolate the operator and the driver making wiring safer. The wire guard prevents the glass from being broken.

## Specifications

- Mounting: Slip Fitter, Universal Bracket, Direct Mounting Bracket, Trunnion Mount
- Accessories: Shield, Wire Guard
- Voltage: 120-277VAC
- Wattage: 30W, 60W, 100W, 150W, 200W, 240W, 300W, 400W
- Lumen Output: 4,050 - 57,200lm
- Efficacy: 120-150Lm/W
- Color Rendering: >70
- Color Temp (K): 5000K
- Lens: Clear glass
- Power Factor: >0.9
- THD: ≤20%
- Housing Color: Gray
- Operating Temp: -40°F to 131°F



## Fixture Details

Product Number	Watts (W)	Voltage (V)	CRI	Efficacy (Lm/W)	CCT (K)	Lumen Output (Lm)	Operating Temperature
IX-HAZA - S1-2-30LO	30	120-277	>70	135	5000	4050	-40°F to 131°F
IX-HAZA - S1-2-60LO	60	120-277	>70	130	5000	7800	-40°F to 131°F
IX-HAZA - S1-2-100LO	100	120-277	>70	130	5000	13000	-40°F to 131°F
X-HAZA - S1-2-150LO	150	120-277	>70	130	5000	19500	-40°F to 131°F
IX-HAZA - S1-2-200LO	200	120-277	>70	130	5000	26000	-40°F to 131°F
IX-HAZA - S1-2-240LO	240	120-277	>70	130	5000	31200	-40°F to 131°F
IX-HAZA - S1-2-300LO	300	120-277	>70	140	5000	42000	-40°F to 131°F
IX-HAZA - S1-2-400LO	400	120-277	>70	143	5000	57200	-40°F to 131°F



# TITAN

VAPOR TIGHT LED



## Description

The Titan has been constructed to be vapor-tight so it can be used in extreme wet conditions and the casing is awarded the highest classification in UL94 Standards. All luminous parts are integrated and easy to remove, making for quick installation of the fixture.

The 5VA housing, wires can be connected directly inside the housing, requiring no junction box or silicone sleeving.

## Specifications

- Mounting: Ceiling mounted or suspended
- Housing: 5V(A)
- CCT: 3500/4000/5000K Selectable
- IP Rating: IP66
- Voltage: 120-277VAC, 120-347VAC, 50/60Hz
- Housing Color: Light gray
- Operating Temp: -40°F to 122°F (suspended)



## Vapor-tight LED Fixture Details

Product Number	Size	Watts (W)	Color Temp (Lm)	CCT (K) Selectable	DLC Product ID
IX-VPT-2FT-30S-50LO	2'	20/25/30	2,600/3,250/3,900	3500/4000/5000	TBA
IX-VPT-4FT-30S-50LO	4'	18/25/30	2,340/3,250/3,900	3500/4000/5000	TBA
IX-VPT-4FT-54S-50LO	4'	38/46/54	4,940 / 5,980/7,020	3500/4000/5000	TBA
IX-VPT-8FT-54S-50LO	8'	38/46/54	4,940/5,980/7,020	3500/4000/5000	TBA
IX-VPT-8FT-90S-50LO	8'	65/75/90	8,450/9,750/11,700	3500/4000/5000	TBA



# AURORA

LINEAR LED HIGH BAY LIGHT

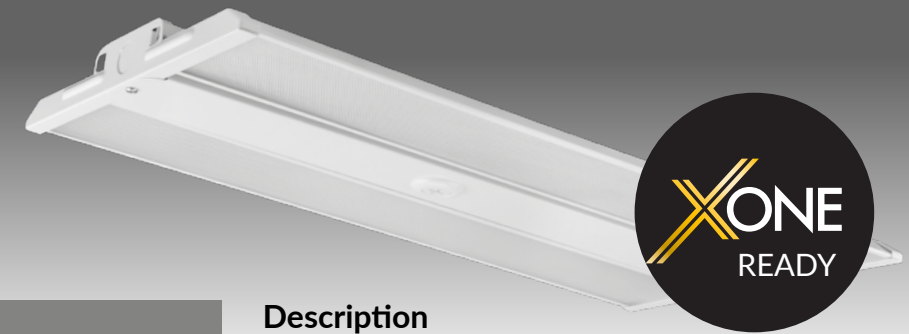

## XONE READY AURORA. FUTUREPROOFING LIGHTING TECHNOLOGY.



## Description

IntrinsiX AURORA Led High Bay Lighting is capable of providing lighting to open spaces with high lumen output. These areas would include airport hangers, factories, warehouses and school gyms.

AURORA LED linear high bay produces a wide light distribution allowing for greater range. It also gives you the freedom to control the brightness with the optional Xone Advanced Lighting Control.

With a lifespan of over 50,000 working hours or 5 years, the AURORA LED lights are perfect for both new build and retrofit applications. These fixtures will have very little maintenance costs compared to the traditional high bay fixtures.

## Specifications

- CCT: 4000/5000K
- Dimming: 0 to 10V
- Voltage: 120 to 277V, 50 to 60Hz
- Efficacy: 140Lm/W
- Operating Temp: -22°F to 122°F
- IP Rating: IP20
- Power Factor: >0.90
- DLC Listing: Premium
- Sensor: Z10 Sensor Base
- Warranty: 50,000 hours/5 years

## Linear High Bay Fixture Details

Product Number	Watts (Selectable)	CCT(K) (Selectable)	CRI	Efficacy (Lm/W)	Lumen Output (Lm)	Operating Temperature	IP Rating	DLC Product ID
IX-LHBX-85S-40/50LO	65/75/85	4000 / 5000	>80	140	11,900/10,500/9,100	-22°F to 122°F	IP20	S-WY6INE
IX-LHBX-110S-40/50LO	70/90/110	4000 / 5000	>80	140	15,400/12,600/9,800	-22°F to 122°F	IP20	S-6LQ48E
IX-LHBX-130S-40/50LO	90/110/130	4000 / 5000	>80	140	18,200/15,400/12,600	-22°F to 122°F	IP20	S-EV6ASP
IX-LHBX-165S-40/50LO	130/150/165	4000 / 5000	>80	140	23,100/21,000/18,200	-22°F to 122°F	IP20	S-JSFZBX
IX-LHBX-220S-40/50LO	180/200/220	4000 / 5000	>80	140	30,800/28,000/25,200	-22°F to 122°F	IP20	S-YGRE1W
IX-LHBX-300S-40/50LO	255/275/300	4000 / 5000	>80	140	42,000/38,500/35,700	-22°F to 122°F	IP20	S-DJYV89
IX-LHBX-420S-40/50LO	320/380/420	4000 / 5000	>80	140	44,800/53,200/58,000	-22°F to 122°F	IP20	TBA

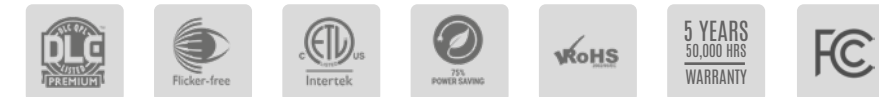

SPECIALTY

INTERIOR

# VISTA

## VISTA SERIES LED LIGHT PANEL



### Description

With the Intrinsic VISTA Series you can depend on an energy efficient design, an ultra-slim backlit panel light fixture which is perfect for renovations or new construction projects that require code compliant energy saving flat panel led solutions.

It also has a smart, smooth, and equal light distribution that ensures a wonderfully illuminated room.

Our VISTA Series LED back lit Light Panel is a flat LED panel ceiling light designed for commercial and industrial applications that require long-lasting efficient lighting such as retail, healthcare, hospitality and office environments.

### Specifications

- CCT: 3500/4000/5000K
- Dimming: 0-10V
- Voltage: 120 to 277V, 50 to 60Hz
- Efficacy: 140Lm/W
- Operating Temp: -4°F to 104°F
- IP Rating: IP20
- Power factor: >0.95
- DLC Listing: Premium
- Warranty: 50,000 Hours/5 Years

### LED Light Panel Fixture Details

Product Number	Size	Watts (Selectable)	CCT(K) (Selectable)	CRI	Efficacy (Lm/W)	Lumen Output Temperature (Lm)	Operating Temperature	IP Rating	DLC Product ID
IX-FPBL-14-20/30/40-CCT	1' x 4'	20/30/40	3500/4000/5000	80+	140	2800/4200/5600	-4°F to 104°F	IP20	S-0M89ET
IX-FPBL-22-20/30/40-CCT	2' x 2'	20/30/40	3500/4000/5000	80+	140	2800/4200/5600	-4°F to 104°F	IP20	S-5WQRKE
IX-FPBL-24-20/30/40-CCT	2' x 4'	20/30/40	3500/4000/5000	80+	140	2800/4200/5600	-4°F to 104°F	IP20	TBA
IX-FPBL-24-30/40/50-CCT	2' x 4'	30/40/50	3500/4000/5000	80+	140	4200/5600/7000	-4°F to 104°F	IP20	S-ORDALS
IX-FPBL-24-30-40L0	2' x 4'	30	4000	80+	140	5600	-4°F to 104°F	IP20	S-6UINLP



# BLE-VISTA

## BLUETOOTH LED



### Description

The latest generation Intrinsic VISTA Series has taken another technological leap forward with Bluetooth integration giving you the ability to operate from a cellphone, tablet or PC.

You can depend on an energy efficient design, an ultra-slim panel light fixture which is perfect for renovations or new construction projects that require code compliant energy saving flat panel LED solutions. It also has a smart, smooth, and equal light distribution that ensures a wonderfully illuminated room.

Our VISTA Series LED back lit Light Panel is a flat LED panel ceiling light designed for commercial and industrial applications that require long-lasting efficient lighting such as retail, healthcare, office and hospitality.

### Specifications

- CCT: 3,000/3,500/4,000/5,000K
- Dimming: 0-10V
- Voltage: 120 to 277V, 50 to 60Hz
- Efficacy: 140Lm/W
- Operating Temp: -4°F to 104°F
- IP Rating: IP20
- Power factor: >0.9
- DLC Listing: Premium
- Bluetooth: Enabled driver installed
- Sensor: BH4S 4 Pin Sensor
- Warranty: 50,000 Hours/5 years

### LED Bluetooth Light Panel Fixture Details

Product Number	Size	Watts (Selectable)	CCT(K) (Selectable)	CRI	Efficacy (Lm/W)	Lumen Output Temperature (Lm)	Operating Temperature	IP Rating	DLC Product ID
IX-BLP-TWC22-30 BLE	2' x 2'	30	3000/3500/4000/5000	>80	125	3750/3780/3810/3840	-4°F to 104°F	IP20	TBA
IX-BLP-TWC24-40 BLE	2' x 4'	40	3000/3500/4000/5000	>80	125	2800/4200/5600	-4°F to 104°F	IP20	TBA

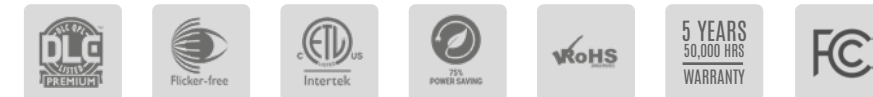

# STRATA

TROFFER LIGHT



## Description

IntrinsiX STRATA Series sets the new standard for all LED center basket troffer lighting. It offers field selectable color temperatures: (3500K, 4000K, 5000K) as well as field selectable wattages making the STRATA the best option for new construction or renovation.

The IntrinsiX STRATA certainly seems like a versatile lighting option, particularly for environments like office spaces, basements, and garages where dropped ceilings are common. Its low maintenance and ability to blend into the ceiling can help create a seamless and unobtrusive lighting solution.

The reduced glare is also a significant benefit, as it can enhance comfort and productivity in work environments while minimizing strain on the eyes. Overall, it is a smart choice for various indoor settings where efficient, comfortable lighting is essential.

## Specifications

- Voltage: 120V to 277V
- Efficacy: 130Lm/W
- Dimming: 0 to 10V
- Power Factor: >0.90
- Color Temp: Selectable 3500/ 4000/5000K
- DLC: Premium
- Warranty: 50,000 Hours/5 Years

## Troffer Fixture Details

Product Number	Size	Watts (Selectable)	CCT(K) (Selectable)	Dimmable	Efficacy Lm/W	Voltage (V)	Options	DLC Product ID
IX-3TRS-22-24/30/36-35/40/50L0	2' x 2'	20/30/36	3500/4000/5000	0 to 10V	130	120 to 277V	EM= Battery backup	PLSEGY0RZRMG
IX-3TRS-24-24/36/45-35/40/50L0	2' x 4'	24/36/45	3500/4000/5000	0 to 10V	130	120 to 277V	EM= Battery backup	PLITI27P8TJ4



# BLE-STRATA

TROFFER LIGHT



## XONE READY STRATA. FUTUREPROOFING LIGHTING TECHNOLOGY.



## Description

The latest generation of the IntrinsiX STRATA Series has taken another technological leap forward with Bluetooth integration giving you the ability to operate from a cellphone, tablet or PC.

IntrinsiX STRATA Series sets the new standard for all LED Troffer Lighting. It offers 4 field selectable color temperatures: (3,000K, 3500K, 4000K, 5000K).

The IntrinsiX STRATA has several advantages over conventional lighting sources, including low maintenance and blending into the ceiling. These fixtures are also less prone to glare than other lighting sources. These are especially helpful in a location with a dropped ceiling like office spaces, basements and garages.

## Specifications

- Voltage: 120V to 277V
- Efficacy: 125Lm/W
- Dimming: 0 to 10V
- Power Factor: >0.90
- Color Temp: 3,000/3500/4000K/5000K
- DLC: Premium
- Bluetooth: Enabled driver installed
- Sensor: BH4S 4 Pin Sensor
- Warranty: 50,000 Hours/5 Years

## Troffer Bluetooth Fixture Details

Product Number	Size	Watts (W)	CCT(K) (Selectable)	Dimmable (V)	Efficacy (Lm/W)	Voltage (V)	Lumens Output (Lm)	DLC Product ID
IX-TR-TWC22-35 BLE	2' x 2'	35	3000/3500/4000/5000	0 to 10	125	120 to 277	4375/4410/4445/4480	TBA
IX-TR-TWC24-45 BLE	2' x 4'	45	3000/3500/4000/5000	0 to 10V	125	120 to 277	4375/4410/4445/4480	TBA



# CIRCA

## ROUND HIGH BAY LED LIGHT



### Description

IntrinsiX CIRCA LED High Bay Lighting is capable of providing lighting to large open spaces. These areas would include airport hangers, factories, and school gyms.

CIRCA LED round high bay lighting produces a cone shaped beam, giving you a more focused light sensor ready and wattage selectable. It also gives you the freedom to control the brightness.

With a lifespan of 50,000 working hours, LED lights are a perfect replacement for traditional lights that easily get worn out. High Bay LED lights will work for a longer period of time with very little maintenance costs.

### Specifications

- Input Voltage: 120 to 277V
- Dimming: 0 to 10V
- Color: 4000K/5000K Selectable
- DLC Listing: Premium
- Sensor: 3 Pin Sensor
- Warranty: 50,000 Hours/5 Years

### Fixture Details

Product Number	Watts (Selectable)	CCT (K) (Selectable)	CRI	Efficacy (Lm/W)	Lumen Output (Lm)	Operating Temperature	IP Rating	DLC Product ID
IX-RHB-100S-40/50L0	60/80/100	4000/5000	>80	140	8673/11564/14455	-40°F to 122°F	IP65	100 S-8A4QSO
IX-RHB-150S-40/50L0	100/120/150	4000/5000	>80	140	14455/14346/21683	-40°F to 122°F	IP65	150 S-L74EVK
IX-RHB-200S-40/50L0	150/180/200	4000/5000	>80	140	21683/26019/28910	-40°F to 122°F	IP65	200 S-07L46W
IX-RHB-240S-40/50L0	200/220/240	4000/5000	>80	140	28910/31801/34692	-40°F to 122°F	IP65	240 S-EJG09S
IX-RHB-300W-50L0	300	5000	>80	140	43365	-40°F to 122°F	IP65	300 S-H9WKGM

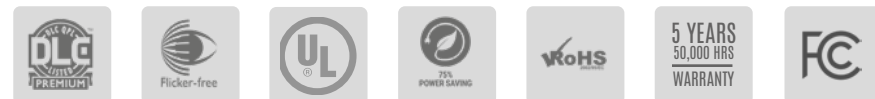

# GALAXIA

## ARCHITECTURAL DOWNLIGHTS



### Description

The GALAXIA range of downlights are available in 4", 6" and 8" widths and white baffle color.

These long-life LEDs provide at least 70% of initial lumen output (L70) for 149,000 hours of operation. They are constructed with an aluminum housing and provide easy installation in new construction or retrofit applications.

They are compatible with 6.30" ceiling cut-outs and 6" mounting frames.

### The color temperatures selectable are:

- 2700K (soft white)
- 3000K (warm white)
- 3500K (warm/neutral white)
- 4000K (neutral white)
- 5000K (cool white)

### Specifications

- Output Power: 6-50W
- Dimming: 0-10V
- Voltage: 120-277VAC, 50/60Hz
- Baffle colors: White
- Power Factor: >0.90
- Operating Temp: <113°F
- Warranty: 50,000 Hours/5 Years

### Downlight LED Fixture Details

Product Number	Size	Lumen Output Selectable (Lm)	CCT (K) Selectable	Watts (W) Selectable	Volts (V)	Power Factor	Dimming Power	Operating Temperature
IX-ER4-2L-LKFS-WHT	4"	500/800/1000	2700/3000/3500/4000/5000	6/9/12	120-277	>0.90	0-10V	<113°F
IX-ER6-2L-LKFS-WHT	6"	1000/1500/2000	2700/3000/3500/4000/5000	10/15/20	120-277	>0.90	0-10V	<113°F
IX-ER8-2L-LKFS-WHT	8"	3000/4000/5000	2700/3000/3500/4000/5000	30/40/50	120-277	>0.90	0-10V	<113°F



# LUMENA

## FIELD SELECTABLE WRAP LIGHT



### Description

The LUMENA Wrap Light is ideal in damp locations and ambient temperatures from -4°F to 140°F and provides easy installation in new construction or retrofit applications.

The long-life LEDs provide 196,000 hours of operation with at least 70% of initial lumen output (L70), and 60,000 hours with at least 90% of initial lumen output (L90).

Lumena is field selectable offering 3500k (warm/neutral white), 4000k (neutral white), and 5000k (cool white) color temperatures.

Lumena provides a range of 4,100 to 5,800 nominal lumens and 132 to 154 lumens per watt (LPW) dependent on color with total harmonic distortion of <20%.

The product is constructed of a steel housing with PMMA lens. Optional emergency drivers and occupancy sensors are available.

### Specifications

- Output Power: 28-41W
- Dimming: 0-10V
- CRI: >80
- Voltage: 120-277VAC, 50/60Hz
- Power Factor: >0.90
- Operating Temp: -4°F to 140°F
- IP Rating: IP20
- Warranty: 50,000 Hours/5 Years

### Wrap Light LED Fixture Details

Product Number	Watts (W)	Lumen Output Selectable	CCT (K) Selectable	Efficacy (Lm/W)	Power Factor	Dimming Power	Operating Temperature	IP Rating	Product ID Code
IX-WRP-30S	30/28/30	4155/4336/4233	3500/4000/5000	138/154/141	> 0.90	0-10V	-4° to 140°F	IP20	TBA
IX-WRP-35S	35/32/35	4750/4932/4817	3500/4000/5000	135/152/137	> 0.90	0-10V	-4° to 140°F	IP20	TBA
IX-WRP-41S	41/39/41	5423/5837/5503	3500/4000/5000	132/149/134	> 0.90	0-10V	-4° to 140°F	IP20	TBA

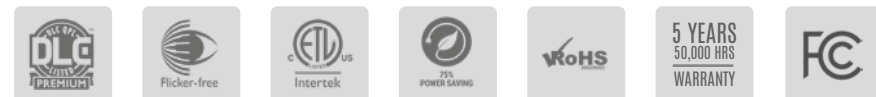

# CELESTA

## LED STRIP LIGHT



### Description

The CELESTA LED strip light is the best in its class for power efficiency when it comes to ceiling-mounted security. They are great for a range of commercial applications including parking lots, shopping malls, hospitals in need of adequate lighting.

These frosted white LED strips are color selectable and wattage adjustable.

The light emitted is soft and uniform with no flicker making these efficient LEDs perfectly safe for any environment.

### Specifications

- Diffuser type: PC Frosted lens round
- Length: 48" (40W), 96" (80W)
- Voltage: 120-277VAC
- IP Rating: IP40
- CRI: >80
- Operating Temp: -22°F to 122°F
- Power Factor: >0.9
- DLC: Premium
- Warranty: 50,000 Hours/5 Year

### LED Strip Fixture Details

Product Number	Length (Ins)	Power (W) Selectable	CCT (K) Selectable	Efficacy Optional	Lumens Output (Lm/W)	Operating Temperature	DLC Product ID
IX-ISF4-20/30/40-30/35/40/50L0	48	20/30/40	3000/3500/4000/5000	122/132/130	4800/5280/5200	-22° to 122°F	S-3HMMYC
IX-ISF8-60/70/80-60/35/40/50L0	96	60/70/80	3000/3500/4000/5000	121/131/137/130	9680/10480/10960/10400	-22° to 122°F	S-15MXW5

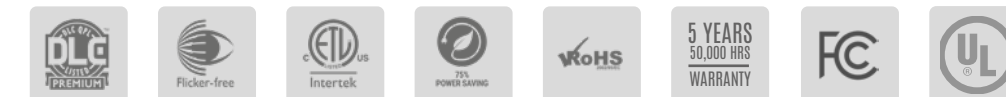

# LINEA X

## ARCHITECTURAL STRIP FIXTURE

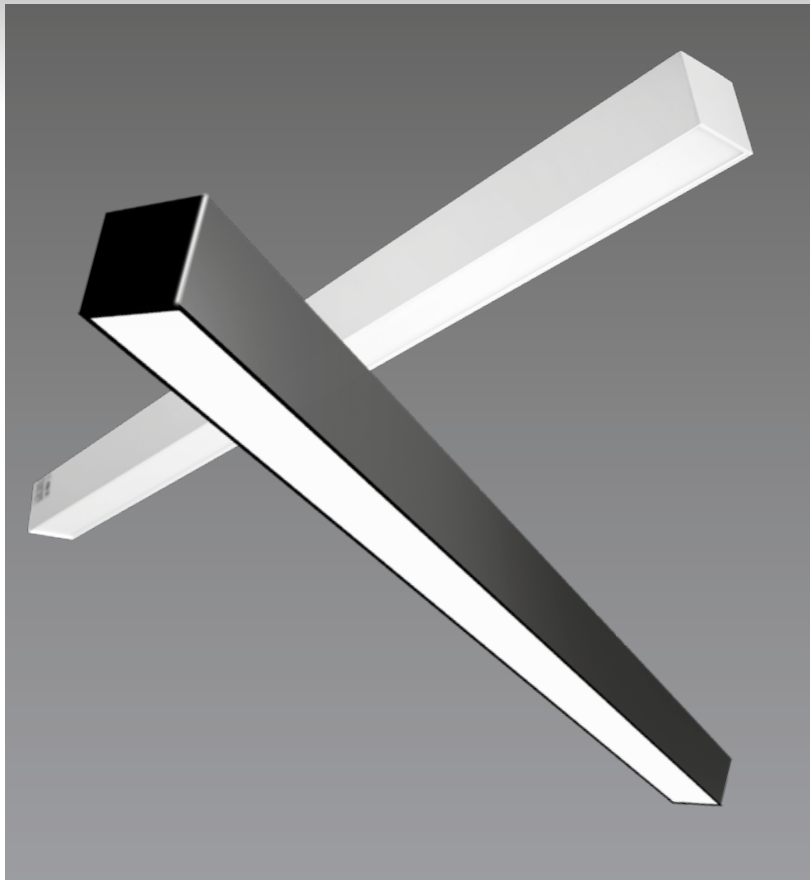
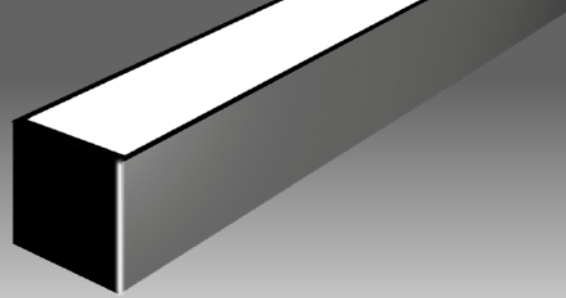

### Description

The Linea X is a 2.75" wide Architectural Linear Fixture. This direct and direct/indirect fixture is available in lengths of 4 and 8' and can be continuously run. This specific modular design can be suspended, mounted on a wall or ceiling giving more flexibility. This is quickly becoming the go to choice for many commercial designers and architects.

- Independently modular direct & indirect luminaries
- Suspended & wall mount available in 4' and 8' lengths, up to 1250 lumens per foot
- Working voltage 120-347V
- Unique end cap simplifies installation, seamless continuous runs or individual units
- Specially designed light source with PC diffuser producing soft light

### Configurations: downlight only

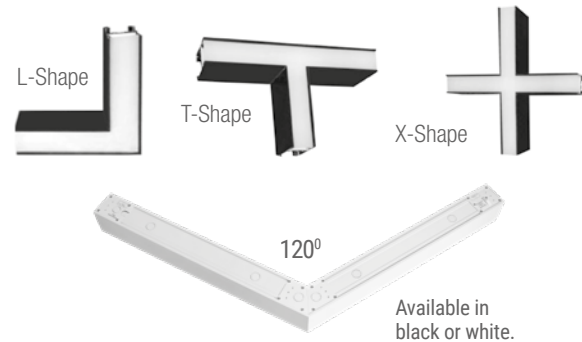

Model	Shape	Watts
L-ASFL-04-20W-35/40/50LO-BK	L-Shape	20W
L-ASFT-04-30W-35/40/50LO-BK	T-Shape	30W
L-ASFX-04-40W-35/40/50LO-BK	X-Shape	40W
L-ASF-120-40W-35/40/50LO	120° angle	40W

### Color control:

Color changeable Up & Down Light

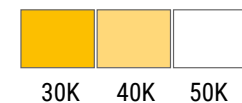

### Strip Fixture details

Product Number	Up/down %	Efficacy (Lm/W)	Size Length	Wattage (W)	CCT (K) Selectable	CRI	Voltage (V)	Lumen output (Lm)	ETL ID
<b>Architectural Strip Fixture</b>									
L-ASF04-40W-35/40/50LO-BK	30/70	130	4'	40W	3500/4000/5000	>80	120-277V	5200	Listed
L-ASF04-40W-35/40/50LO-WH	30/70	130	4'	40W	3500/4000/5000	>80	120-277V	5200	Listed
L-ASF04-U/D-50W-35/40/50LO-BK	30/70	130	4'	50W	3500/4000/5000	>80	120-277V	6500	Listed
L-ASF04-U/D-50W-35/40/50LO-SV	30/70	130	4'	50W	3500/4000/5000	>80	120-277V	6500	Listed
L-ASF04-U/D-50W-35/40/50LO-WH	30/70	130	4'	50W	3500/4000/5000	>80	120-277V	6500	Listed
L-ASF08-70W-35/40/50LO-BK	30/70	130	8'	70W	3500/4000/5000	>80	120-277V	9100	Listed
L-ASF08-70W-35/40/50LO-WH	30/70	130	8'	70W	3500/4000/5000	>80	120-277V	9100	Listed
L-ASF08-U/D-100W-35/40/50LO-BK	30/70	130	8'	100W	3500/4000/5000	>80	120-277V	13000	Listed
L-ASF08-U/D-100W-35/40/50LO-WH	30/70	130	8'	100W	3500/4000/5000	>80	120-277V	13000	Listed
<b>Recessed Mount Architectural Strip Fixture</b>									
L-RMASF04-40W-35/40/50LO-BK		130	4'	40W	3500/4000/5000	>80	120-277V	5200	Listed
L-RMASF04-40W-35/40/50LO-WH		130	4'	40W	3500/4000/5000	>80	120-277V	5200	Listed
L-RMASF08-70W-35/40/50LO-BK		130	8'	70W	3500/4000/5000	>80	120-277V	9100	Listed
L-RMASF08-70W-35/40/50LO-WH		130	8'	70W	3500/4000/5000	>80	120-277V	9100	Listed
<b>Architectural Strip Fixture L Bracket</b>									
L-ASFL-20W-35/40/50LO-BK		130		20W	3500/4000/5000	>80	120-347V	2600	Listed
L-ASFL-20W-35/40/50LO-WH		130		20W	3500/4000/5000	>80	120-347V	2600	Listed
<b>Architectural Strip Fixture T Bracket</b>									
L-ASFT-30W-35/40/50LO-BK		130		30W	3500/4000/5000	>80	120-347V	3900	Listed
L-ASFT-30W-35/40/50LO-WH		130		30W	3500/4000/5000	>80	120-347V	3900	Listed
<b>Architectural Strip Fixture X Bracket</b>									
L-ASFL-40W-35/40/50LO-BK		130		40W	3500/4000/5000	>80	120-347V	5200	Listed
L-ASFL-40W-35/40/50LO-WH		130		40W	3500/4000/5000	>80	120-347V	5200	Listed
<b>Architectural Strip Fixture 120°</b>									
L-ASF120-40-35/40/50LO-BK		130		40W	3500/4000/5000	>80	120-277V	5200	Listed
L-ASF120-40-35/40/50LO-WH		130		40W	3500/4000/5000	>80	120-277V	5200	Listed

\*Only available in 4" direct and indirect

### Accessories:

Model	Product Code	Status	Description	ETL
Power Cable	L-ASF-PC-Black, L-ASF-PC-White	Optional	AC, 8' length, 5-Core	Yes
Aircraft Cable	STL	Standard	8' length, 1 Pair	Yes
Canopy Kits	L-ASF-CB-Black, L-ASF-CB-White	Optional	Canopy A & B - 125mm	Yes
Wall Mount Kit	L-ASF04-WMK-BK, L-ASF04-WMK-WH	Optional	Includes all fixings	Yes
Linkable Kit	4FTLBK / 8FTLBK	Optional	Bracket + Internal 5-pins, Power cable	Yes
PIR Sensor				No
Motion Sensor				No
Emergency Backup				No
2.4G Wireless Control				No

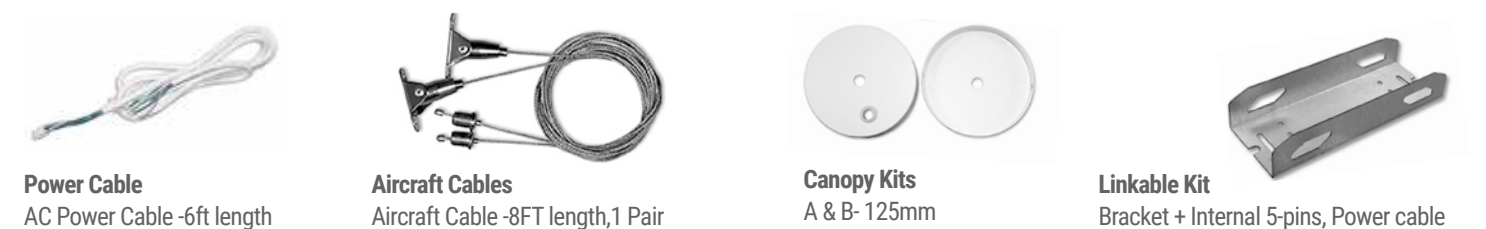

### Mounting Options

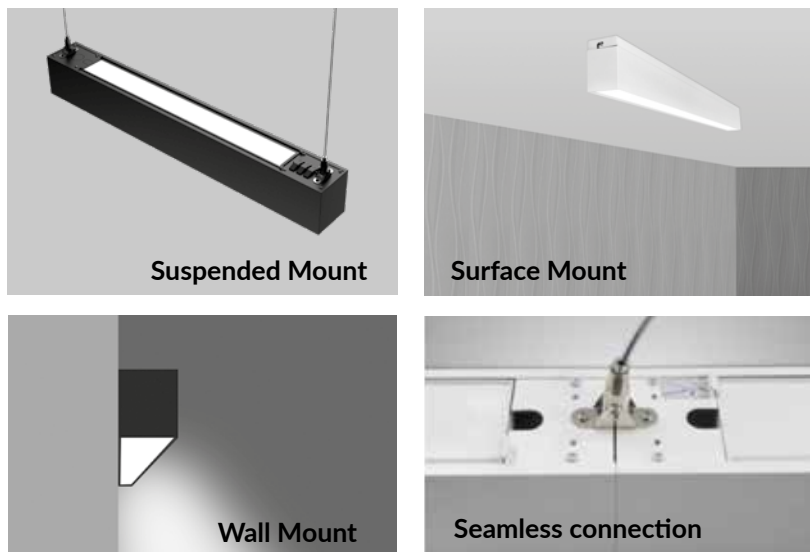

# LINEA R

## RECESSED SLOT FIXTURE

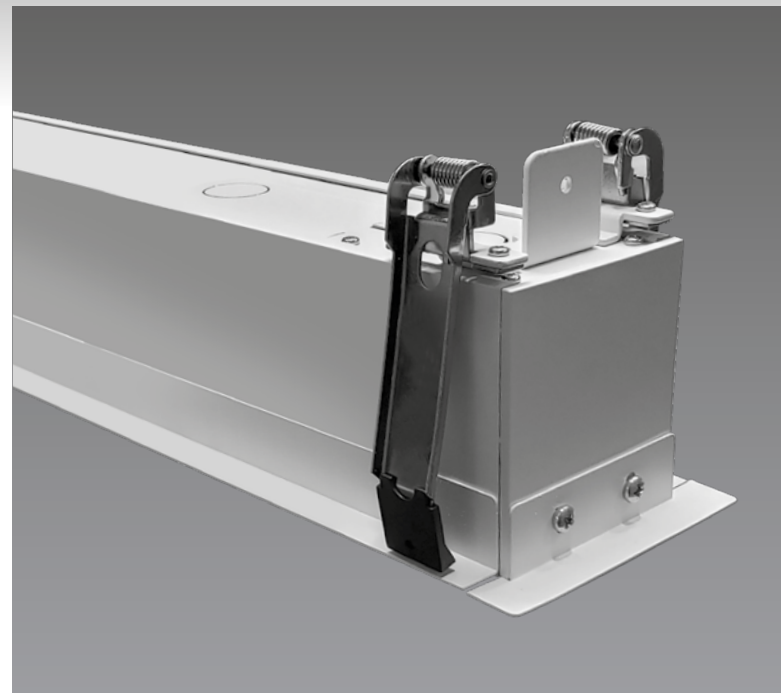

### Description

The IntrinsicX Linea R fixture is incredibly versatile and functional for office environments!

The option to adjust color temperature between 3,500K, 4,000K, and 5,000K is also a great feature, allowing for customization based on the desired ambiance or task lighting needs. And the slim design ensures it integrates well with modern office aesthetics without being obtrusive. Overall, it is a well-designed lighting solution for creating a comfortable and productive workspace.

### Specifications

- Voltage: 120V to 347V
- Dimming: 0-10V
- Efficacy: 130Lm/W
- Delivered Lumens: 2600-9100Lm
- CRI: >80
- DLC Listing: Premium
- Warranty: 50,000 hours/5 Years

### Product Details

Model Number	Product Length	Power (W)	CCT (K) Optional	Voltage (V) ETL	CRI	Lumen Output Temp (Lm)	Efficacy (Lm/W)	Dimming
L-RMASF04-40W-35/40/50LO-BK	4'	40	3500/4000/5000	120 to 347	>80	2600 to 9100	130	0 to 10
L-RMASF04-40W-35/40/50LO-WH	4'	40	3500/4000/5000	120 to 347	>80	2600 to 9100	130	0 to 10
L-RMASF08-70W-35/40/50LO-BK	8'	70	3500/4000/5000	120 to 347	>80	2600 to 9100	130	0 to 10
L-RMASF08-70W-35/40/50LO-WH	8'	70	3500/4000/5000	120 to 347	>80	2600 to 9100	130	0 to 10

### Mounting Kits & Accessories



**Linkable Bracket**  
LASF-LB 4ft



**Recessed Mount Kits**



#### Power Cord

- L-ASF-PC-Black Black 8ft
- L-ASF-PC-White White 8ft



# STORM

## STAINLESS STEEL HAND DRYER

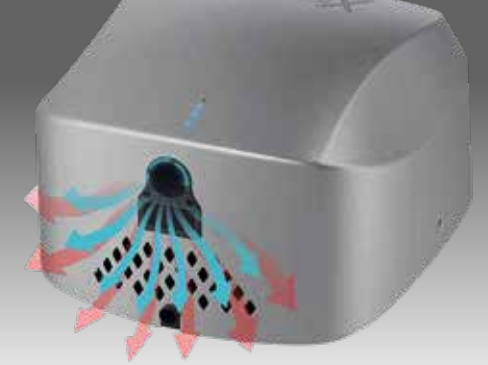

### Description

**Robust Construction:** The Storm has been meticulously fashioned from high-grade stainless steel giving it unwavering strength and resilience, ensuring enduring performance and resistance to corrosion even in demanding environments.

**Intelligent Heating System:** Utilizing an intelligent heating mechanism, The Storm dryer efficiently regulates its temperature, conserving energy by automatically deactivating when not in use, ensuring an eco-friendly and cost-effective operation.

**Cutting-Edge HEPA Filtration:** Featuring a cutting-edge built-in HEPA filter, The Storm guarantees a pristine and contaminant-free airflow, promoting a hygienic and germ-free drying experience for users.

**Certified Compliance:** Fully complying with UL standards, The Storm hand dryer comes with comprehensive safety features including over-current and overheat protection, as well as a 45-second overtime protection, ensuring a secure and reliable user experience.



### Specifications

- Model Number: IX-STHD-120
- Sensor: Yes
- Voltage (V): 110V-130V
- Power (W): 1400W
- Heating Power: 650W-750W
- Power Source: Electric
- Dimension: 11.8" L x 7.0" W x 11.8" H
- Sensing Distance: 6-8"
- Case Material: 304 Stainless Steel
- Waterproof Level: IP14
- Drying Time: 10-15s
- Certification: CE, CB, GS, UL, ROHS, PSE, GCC, SAA, REACH
- Application: Commercial, Household and etc.
- Warranty: 2 Years



# HAZA-EXEP

EXPLOSION PROOF LED CLASS 1 DIVISION 1

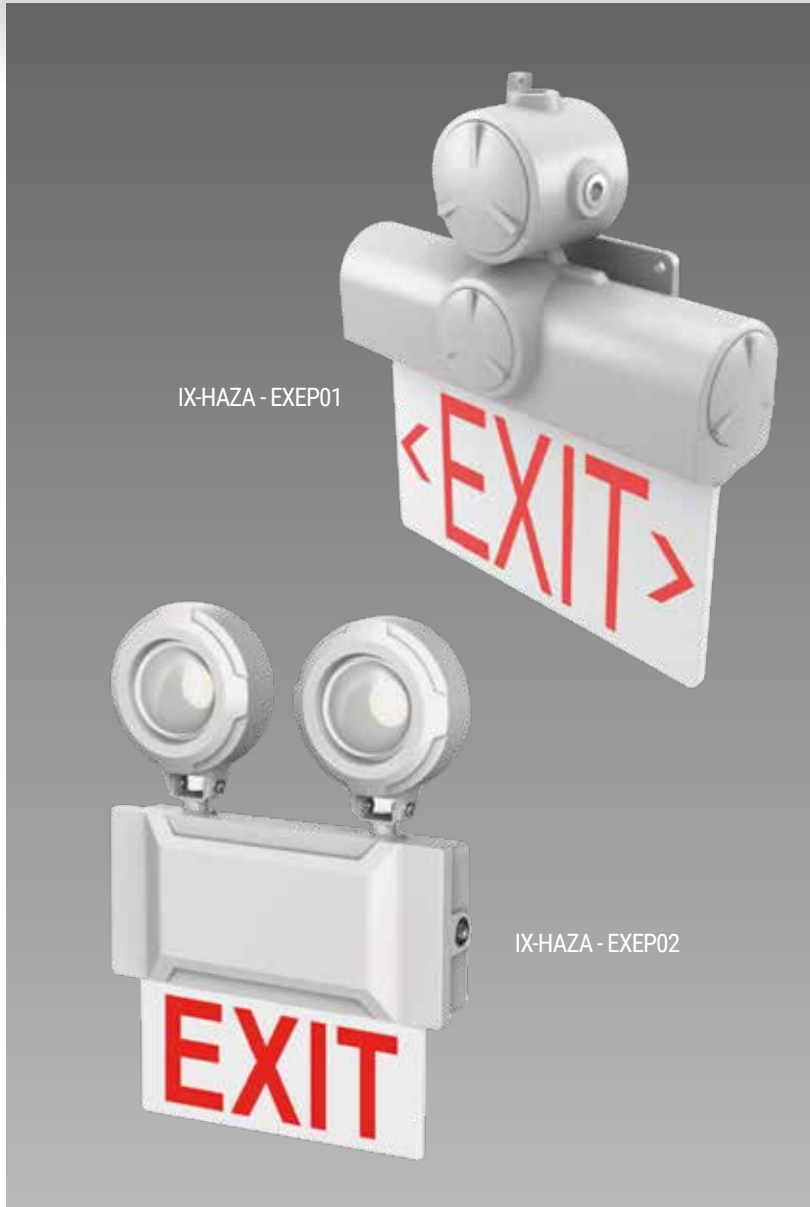

IX-HAZA - EXEP01

IX-HAZA - EXEP02

## Description

The HAZA Explosion proof exit sign provides emergency back up for up to 180 minutes in case of a power failure or accident. There are three mounting options - wall mounted, pendant mounted or end bracket mount installation. The HAZA exit light is provided with optional 3/4" or M25 1.5 conduit threaded hub.

HAZA Exit lights are suitable for various complicated environments due to the thick shell making them explosion-proof and durable.

Applications include warehouses, factories and workshops, petroleum and refineries, gas stations, power, railways, ports, public security, and fire safety exits etc.

## Specifications

- Mounting: Wall, pendant, end bracket mount
- EXIT color: Red or green
- Voltage: 120-240VAC, 120-277VAC, and 277-480VAC, 50/60Hz
- Emergency Time: Div 1 >180 minutes  
Div 2 >90 minutes
- Housing Color: Gray
- Operating Temp: -32°F to 140°F
- Warranty: 50,000 Hours/5 Years

## Hazard LED Fixture Details

Product Number	Division	Watts (W)	Voltage (V)	IP Code	Battery Type	Emergency Conversion	Emergency Time	Operating Temperature
IX-HAZA - EXEP01	1	3	120-240, 120-277	-	Lithium	< 1s	>180 mins	-32°F to 140°F
IX-HAZA - EXEP02	2	3	120-240, 120-277	IP66	Lithium	< 1s	>90 mins	-32°F to 140°F



# HAZA-EXL

LED EXIT SIGN AND LIGHT CLASS 1 DIVISION 2



IX-HAZA-EMEX

IX-HAZA-EMEXL

## Description

The HAZA Exit sign and Light provides emergency back up for up to 90 minutes in case of a power failure or accident. There are two mounting options - wall mounted, or ceiling mounted.

They are constructed with flame retardant /UV resistant plastic providing light weight and strong fixture body to prevent long term failure from damage.

With the snap-on/off design it is easy to remove and replace the surface cover and lamp heads. The light will automatically carry out a charging and discharging procedure to ensure normal function and will send out an alarm if the light gets damaged.

HAZA Exit lights are suitable for various environments including warehouses, factories and workshops, petroleum and refineries, gas stations, power, railways, ports, public security, fire safety exits etc.

## Specifications

- Mounting: Wall, ceiling
- CRI: >80
- EXIT color: Red or green
- Voltage: 120-240VAC, 120-277VAC, and 277-480VAC, 50/60Hz
- Emergency Time: >90 minutes
- Housing Color: White
- Operating Temp: -32°F to 122°F
- Color Temp: 5000K
- Warranty: 50,000 Hours/5 Years

## Hazard LED Fixture Details

Product Number	Watts (W)	Voltage (V)	CCT (K)	Side lights	Battery Type	Emergency Conversion	Emergency Time	Operating Temperature
IX-HAZA-EMEX	3	120-240, 120-277	5000	No	Ni-MH Lithium	< 1s	>90 mins	-32°F to 122°F
IX-HAZA-EMEXL	3	120-240, 120-277	5000	Yes	Ni-MH Lithium	< 1s	>90 mins	-32°F to 122°F



# ILLUMINA-XM

## LED EXIT SIGN AND LIGHT

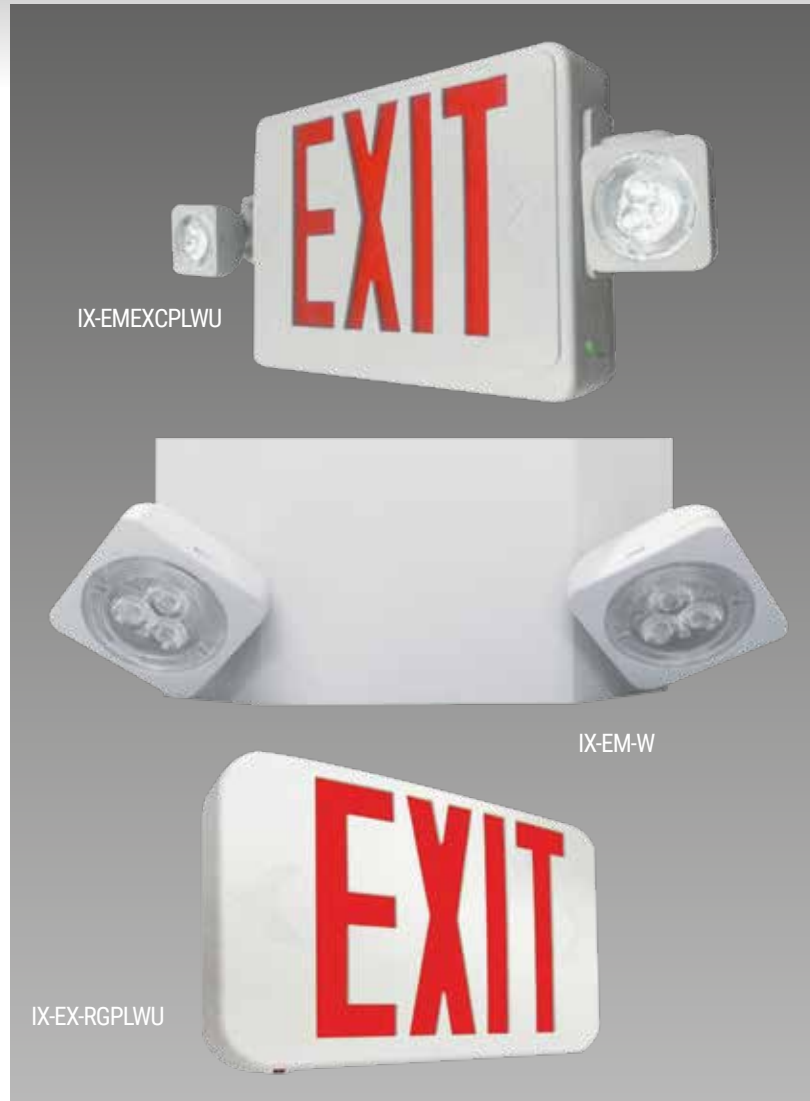

### Description

The Illumina-XM range is constructed from thermoplastic for a reduced profile, ideal for tight areas. The construction allows for locating in damp areas and they are also flame retardant.

The range features charge rate/power "ON" LED indicator light and push-to-test switch for mandated code compliance testing and a long life, maintenance-free, rechargeable NiCd battery.

An Internal solid-state transfer switch automatically connects the internal battery to LED lamp heads for a minimum of 90-minute emergency illumination.

Fully automatic solid-state, two rate charger initiates battery charging to fully recharge the battery in 24 hours.

### Specifications

- Housing: 5V(A)
- IP Rating: IP66
- Voltage: 120-277VAC, 50/60Hz
- Housing Color: White
- Operating Temp: 32°F to 122°F
- Warranty: 50,000 Hours/5 Years

### Exit Sign/Light LED Fixture Details

Product Number	Volts (V)	Watts (W)	Battery (Rechargeable)	Emergency Illumination	Housing Color	Operating Temperature
IX-EMEXCPLWU	120-277	1.2 - 3.0	NiCd	90 minutes	White	32°F to 122°F
IX-EM-W	120-277	0.6 - 1.0	NiCd	90 minutes	White	32°F to 122°F
IX-EX-RGPLWU	120-277	1.0 - 2.7	NiCd	90 minutes	White	32°F to 122°F



# SPECTRA

## GAS STATION CANOPY

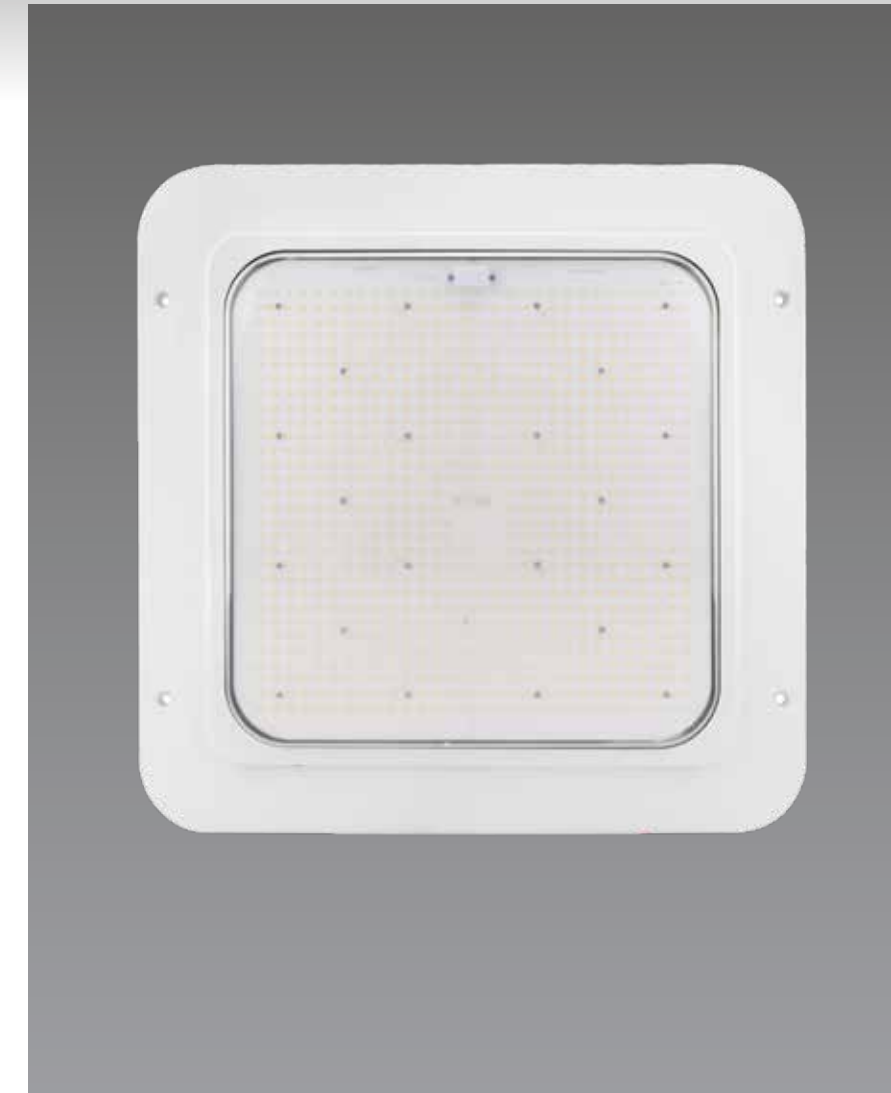

### Description

The SPECTRA Gas Station LED canopy light is the best in its class for power efficiency when it comes to ceiling-mounted security.

They are great for a range of commercial applications including gas stations, shopping malls, underground parking lots, hospitals, warehouses, factories and any other areas in need of adequate lighting.

These white housed LED canopies are easy to install.

### Specifications

- Voltage: 120-277VAC
- IP Rating: IP65
- Operating Temp: -40°F to 113°F
- Power Factor: >0.9
- DLC: Premium
- Warranty: 50,000 hours/5 Years

### Canopy Fixture Details

Product Number	Power (W)	CCT (K)	CRI	Efficacy (Lm/W)	Lumens Output Temperature (Lm)	Operating Temperature	IP Rating	DLC Product ID
IX-PCNP-180-50L0	180W	5000	>80	140	25,420	-40°F to 113°F	IP65	S-TGTZKP



# TRITON

LED CANOPY LIGHT



### Description

The TRITON LED canopy light is the best in its class for power efficiency when it comes to ceiling-mounted security.

They are great for a range of commercial applications including gas stations, shopping malls, underground parking lots, hospitals, warehouses, factories and any other areas in need of adequate lighting.

These color and wattage selectable LED canopies are easy to install.

### Specifications

- Voltage: 120-277VAC
- IP Rating: IP65
- Operating Temp: -40°F to 122°F
- Power Factor: >0.9
- DLC: Premium
- Sensor: 3 Pin Sensor Base
- Warranty: 50,000 Hours/5 Years

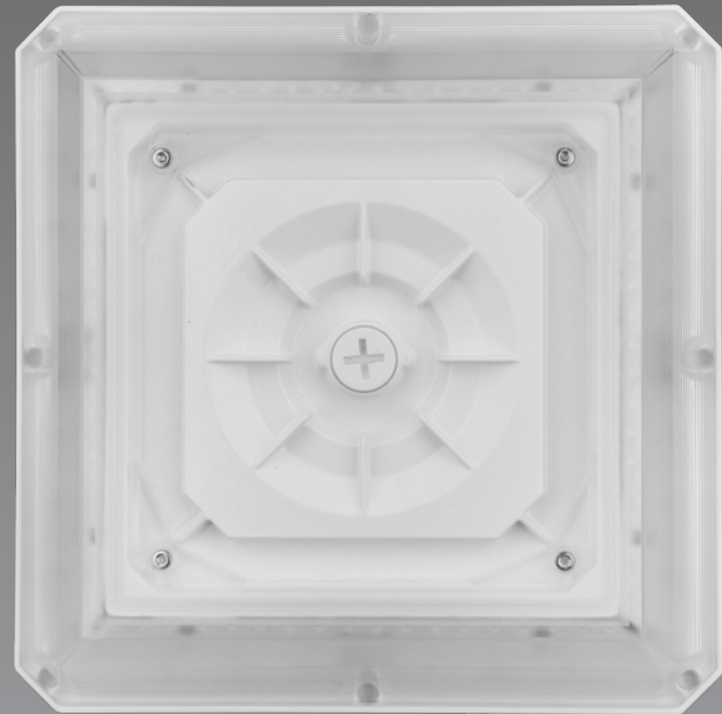

### Canopy Fixture Details

Product Number	Power (W)	CCT (K) Optional	CRI	Efficacy (Lm/W)	Lumens Output Temperature (Lm)	Operating Temperature	IP Rating	DLC Product ID
IX-CNP-40/60/75-30/40/50L0	40/60/75	3000/4000/5000	>80	124-134	9300-10050	-40°F to 122°F	IP65	S-7RCBDK



# METEOR

SPORTS LED LIGHT



### Description

The METEOR Light is designed specifically with sports in mind. It is ideally located in Gymnasiums, sports arenas, stadiums, pitches, fields but also for square plazas, shipyards, airports and wharfs.

This energy saving, long lifespan LED light features Instant start with a constant output which can be adjusted through output cable with 0-10V.

Meteor is eco-friendly and complies with the UL cUL DLC-V5.1 (Premium) certificate.

### Specifications

- Output Power: 450W or 600W
- Dimming: 0-10V
- CRI: >80
- Voltage: 200-480VAC, 50/60Hz
- Power Factor: >0.90
- Operating Temp: -40°F to 113°F
- Warranty: 50,000 Hours/5 Years



### Sports Light LED Fixture Details

Product Number	Watts (W)	Volts (V)	Lumen Output Selectable (Lm)	CCT (K)	Efficacy (Lm/W)	Power Factor	Dimming Power (V)	Operating Temperature	Product ID Code
IX-SPL-450S-50UV	450	200-480	75150/75600/75600	4000/5000/5700	167/168/168	>0.90	0-10	-40° to 113°F	TBA
IX-SPL-600S-50UV	600	200-480	98400/98400/99000	4000/5000/5700	164/164/165	>0.90	0-10	-40° to 113°F	TBA

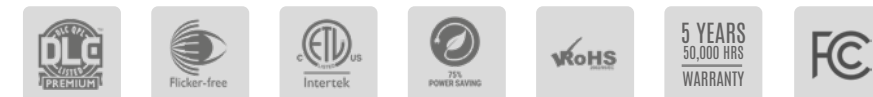

# ECLIPSE

## FULL-CUT WALL PACK



### Description

The ECLIPSE LED Full Cut Wall Pack is the best in its class for power efficiency when it comes to wall-mounted security. They are great for a range of commercial applications including doorways, walkways, and any other outdoor areas in need of adequate lighting.

With the use of the Intrinsic ECLIPSE full cut wall pack lights, you get the incredible power of LED lights combined with the sturdy construction needed for outdoor lighting.

The ECLIPSE provides security lighting with control over the energy efficiency with its integrated Photocell capabilities. These security lights are more economical, replacing the HID or HPS lights, consuming less electricity and giving you even brighter lighting compared to conventional lights.

### Specifications

- Photocell: Integrated
- Dimming: 0 to 10V
- Voltage: 120 to 277V, 50 to 60Hz
- IP Rating: IP65
- Operating temp: -20°F to 140°F
- Power Factor: >0.95
- DLC: Premium
- Warranty: 50,000 Hours/5 years

### Wall Pack Fixture Details

Product Number	Power (W)	CCT (K) Optional	CRI	Efficacy (Lm/W)	Lumens Output Temperature (Lm)	Operating Temperature	IP Rating	DLC Product ID
IX-FCWP-0048-50LO	48W	5000K	70+	110	5280	-20°F to 140°F	IP65	PL5B5Q6124ZP
IX-FCWP-0060-50LO	60W	5000K	70+	110	6600	-20°F to 140°F	IP65	PL65KNXVWIKC
IX-FCWP-0080-50LO	80W	5000K	70+	110	8800	-20°F to 140°F	IP65	PLY3PUCC8HPA

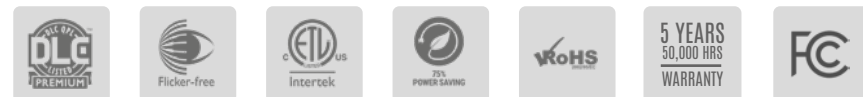

# ECLIPSE

## SEMI-CUT WALL PACK

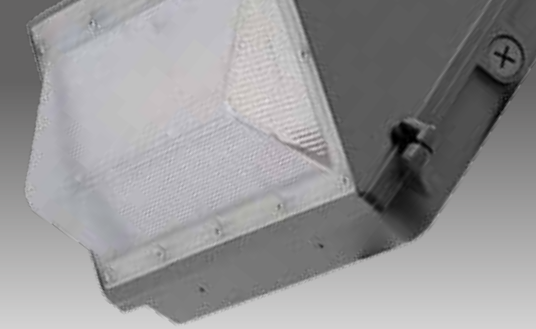

### Description

The ECLIPSE LED Semi Cut Wall Pack is the best in its class for power efficiency when it comes to wall-mounted security.

They are great for a range of commercial applications including parking lots, shopping malls, hospitals, walkways, and any other outdoor areas in need of adequate lighting. With the use of the Intrinsic ECLIPSE semi-cut wall pack lights, you get the incredible power of LED lights combined with the sturdy construction needed for outdoor lighting.

The ECLIPSE provides security lighting with control over the energy efficiency with its integrated Photocell capabilities.

These security lights are more economical, replacing the HID or HPS lights, consuming less electricity and giving you even brighter lighting compared to conventional lights.

### Specifications

- Photocell: Integrated
- Voltage: 120 to 277V, 50 to 60Hz
- IP Rating: IP65
- Operating Temp: -20°F to 140°F
- Power Factor: >0.95
- DLC: Premium
- Warranty: 50,000 Hours/5 Years

### Wall Pack Fixture Details

Product Number	Power (W)	CCT (K) Optional	CRI	Efficacy (Lm/W)	Lumens Output Temperature (Lm)	Operating Temperature	IP Rating	DLC Product ID
IX-SCWP-48-50LO	48W	5000K	70+	110	5280	-20°F to 140°F	IP65	PL0W8WFD0MSN
IX-SCWP-60-50LO	60W	5000K	70+	110	6600	-20°F to 140°F	IP65	PL5NF3NEDD1X
IX-SCWP-80-50LO	80W	5000K	70+	110	8800	-20°F to 140°F	IP65	PLSOPZ74PMK9
IX-SCWP-100-50LO	100W	5000K	70+	110	11000	-20°F to 140°F	IP65	PLUHGWKPA698
IX-SCWP-130-50LO	130W	5000K	70+	110	14300	-20°F to 140°F	IP65	TBA



# LUNA

LED SEMI-CUTOFF WALL PACK

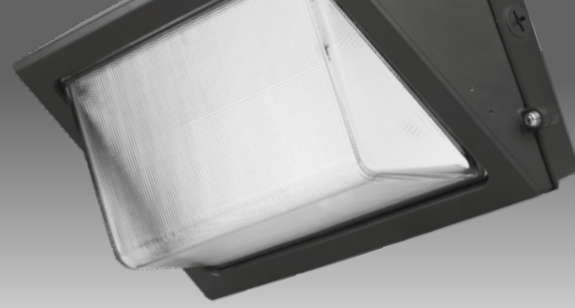

## Description

The LUNA LED Semi-Cutoff Wall Pack is the best in its class for power efficiency when it comes to wall-mounted security. They are great for a range of commercial applications including parking lots, shopping malls, hospitals, walkways, and any other outdoor areas in need of adequate lighting.

With the use of the IntrinsicX LUNA LED Semi-Cutoff Wall Pack lights, you get the incredible power of LED lights combined with the sturdy construction needed for outdoor lighting.

The LUNA provides security lighting with control over the energy efficiency with its integrated Photocell capabilities. These security lights are more economical, replacing the HID or HPS lights, consuming less electricity and giving you even brighter lighting compared to conventional lights.

## Specifications

- Photocell: Integrated
- Voltage: 120-277VAC
- IP Rating: IP65
- Operating Temp: -40°F to 122°F
- Power Factor: >0.9
- DLC: Premium
- Warranty: 50,000 hours/5 Years



## Wall Pack Fixture Details

Product Number	Power (Watts)	CCT (K) Optional	CRI	Efficacy (lm/W)	Lumens Output Temperature (Lm)	Operating Temperature	IP Rating	DLC Product ID
IX-SWP-25/30/40-30/40/50LO	25/30/40W	3000/4000/5000K	>80	136-140	5440-5600	-40°F to 122°F	IP65	S-NY8YZG
IX-SWP-45/60/80-30/40/50LO	45/60/80W	3000/4000/5000K	>80	139-142	11080-11290	-40°F to 122°F	IP65	S-7DTZX9
IX-SWP-80/100/120-30/40/50LO	80/100/120W	3000/4000/5000K	>80	138-152	17140-17250	-40°F to 122°F	IP65	S-PCMTY7



# ECLIPSE

MINI WALL PACK

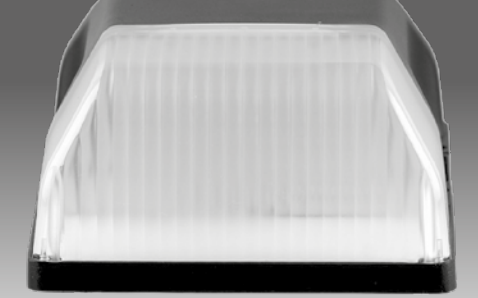

## Description

The IntrinsicX ECLIPSE LED Mini Wall Pack is the best in its class for power efficiency when it comes to wall-mounted security. With our selection of LED mini wall pack lights, you get powerful lighting that is just right for your smaller space.

When you need less lighting for a smaller space, such as a doorway, hallway, The Eclipse Mini LED wall pack lights are a great solution.

With the use of the IntrinsicX ECLIPSE Mini wall pack lights and the integrated Photocell capabilities you have control, you get the incredible power of LED lights combined with the sturdy construction needed for outdoor lighting.

## Specifications

- Photocell: Integrated
- Voltage: 120 -277V, 50-60Hz.
- Efficacy: 135Lm/Wt
- Operating Temp: -4°F to 113°F
- IP Rating: IP65
- Power Factor: >0.90
- DLC Listing: Premium
- Warranty: 50,000 Hours/5 Years



## Wall Pack Fixture Details

Product Number	Power (Watts)	CCT (K)	CRI	Efficacy (lm/W)	Lumens Output Temperature (Lm)	Operating Temperature	IP Rating
IX-MWP03-15W-50LO	15W	5000K	80+	130	1950	-4°F to 113°F	IP65
IX-MWP03-20W-50LO	20W	5000K	80+	130	2700	-4°F to 113°F	IP65
IX-MWP03-30W-50LO	30W	5000K	80+	130	3900	-4°F to 113°F	IP65



# LUNA MINI

WALL PACK

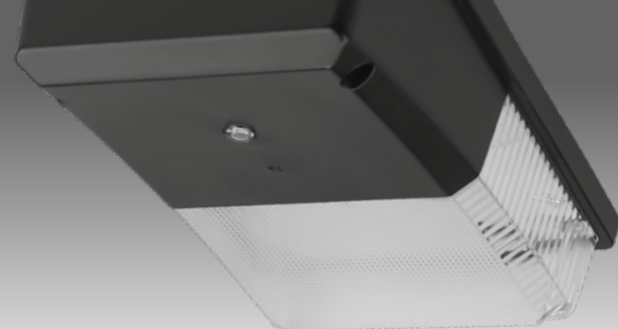

## Description

The IntrinsicX Luna LED Mini Wall Pack is the best in its class for power efficiency when it comes to wall-mounted security.

With our selection of LED wall pack lights, you get powerful lighting that is just right for your space.

With the use of the IntrinsicX Luna Mini wall pack lights and the integrated Photocell capabilities you have control, you get the incredible power of LED lights combined with the sturdy construction needed for outdoor lighting.

## Specifications

- Photocell: Integrated
- Voltage: 120 -277V, 50-60Hz.
- Efficacy: 125-140Lm/Wt
- Operating Temp: -4°F to 113°F
- Dimming: 0-10V
- IP Rating: IP65
- Power Factor: >0.90
- DLC Listing: Premium
- Warranty: 50,000 Hours/5 Years



## Wall Pack Fixture Details

Product Number	Power (W) Adjustable	CCT (K) Optional	CRI	Efficacy (Lm/W)	Lumens Output Temperature (Lm)	Operating Temperature	IP Rating	DLC Product ID
IX-MWP-30S-30/40/50L0	15/20/30	3000/4000/5000	80+	125/141/134	3700/4200/4000	-4°F to 113°F	IP65	TBA



# SIRIUS GEN 2

LED SHOEBOX LIGHT

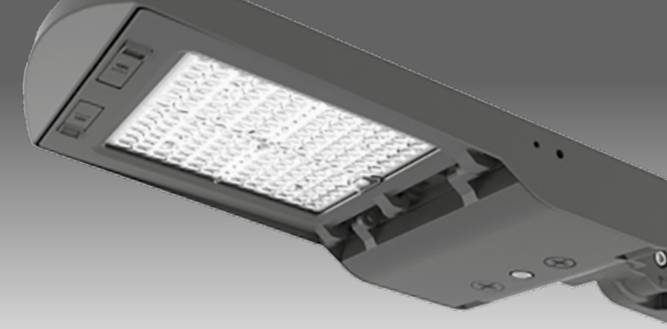

## Description

The IntrinsicX Sirius Gen 2 combines the duo of architectural form and versatility to make it an excellent choice for new construction or for retro-fit applications. It is offered in a variety of wattages (80/150/300) allowing for maximum flexibility in all types of applications.

The high output LEDs and custom engineered optics provide excellent uniformity and efficiency.

It is designed to replace the existing HID fixtures up to 1000W.

## Specifications

- CCT: 3,000/4,000/5,000 Selectable
- Dimming: 0-10V
- Voltage: 100 to 277V, 50 to 60Hz
- Operating Temp: -40°F to 131°F
- IP Rating: IP65
- Power Factor: >0.90
- Sensor: Occupancy Sensor (Optional)  
Exterior Photocell (Optional)  
Integral Sensor Receptacle
- DLC Listing: Premium
- Warranty: 50,000 Hours/5 Years
- Distribution patterns: T2, T3, T4, T5



## Fixture Details

Product Number	Watts (W)	Voltage (V)	CCT (K)	CRI	Efficacy (Lm/W)	Lumen Output (Lm)	Operating Temperature	IP Rating	DLC Product ID
IX-ALZ-80S-30/40/50L0	80	120-277	3000/4000/5000	>80	130/150/145	10880/12000/11600	-40° F to 131° F	IP65	TBA
IX-ALZ-150S-30/40/50L0	150	120-277	3000/4000/5000	>80	130/150/145	20250/22500/21150	-40° F to 131° F	IP65	TBA
IX-ALZ-150S-30/40/50H0	150	277-480	3000/4000/5000	>80	135/150/145	20250/22500/21150	-40° F to 131° F	IP65	TBA
IX-ALZ-300S-30/40/50L0	300	120-277	3000/4000/5000	>80	135/150/140	40500/45000/42000	-40° F to 131° F	IP65	TBA
IX-ALZ-300S-30/40/50H0	300	277-480	3000/4000/5000	>80	135/150/140	40500/45000/42000	-40° F to 131° F	IP65	TBA

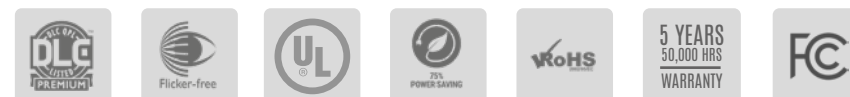

# SIRIUS

## SHOE BOX LIGHT

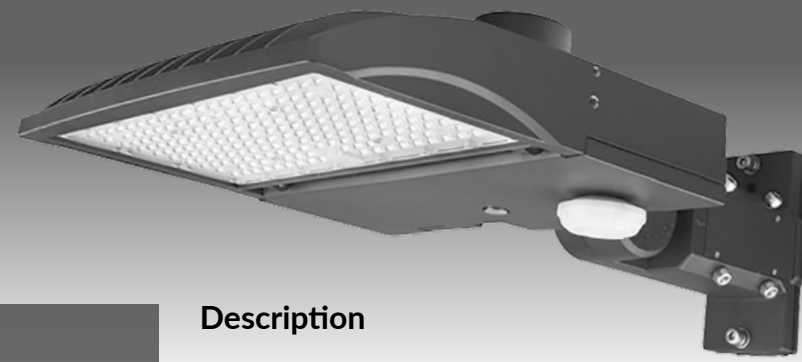

### Description

The Intrinsic SIRIUS Shoe Box Light offers an energy efficient eco-friendly option for commercial uses, such as large walkways, outside office buildings and parking lots. The prime goal is safety and security for people and your property.

The SIRIUS Shoe Box allows you to have complete control over the amount of light, with the option of adding advanced lighting controls.

They are high quality, durable and energy efficient light that is guaranteed to last at least 50,000 hours.

### Specifications

- CCT: 5000K
- Dimming: 0 to 10V
- Voltage: 120 to 277V, 50 to 60Hz
- Efficacy: 140Lm/W
- Operating Temp: -58°F to 122°F (without sensor)
- Operating Temp: -31°F to 122°F (with sensor)
- IP Rating: IP65
- Power factor: ≥0.9
- Mounting: Universal
- DLC Listing: Premium
- Warranty: 50,000 Hours/5 years

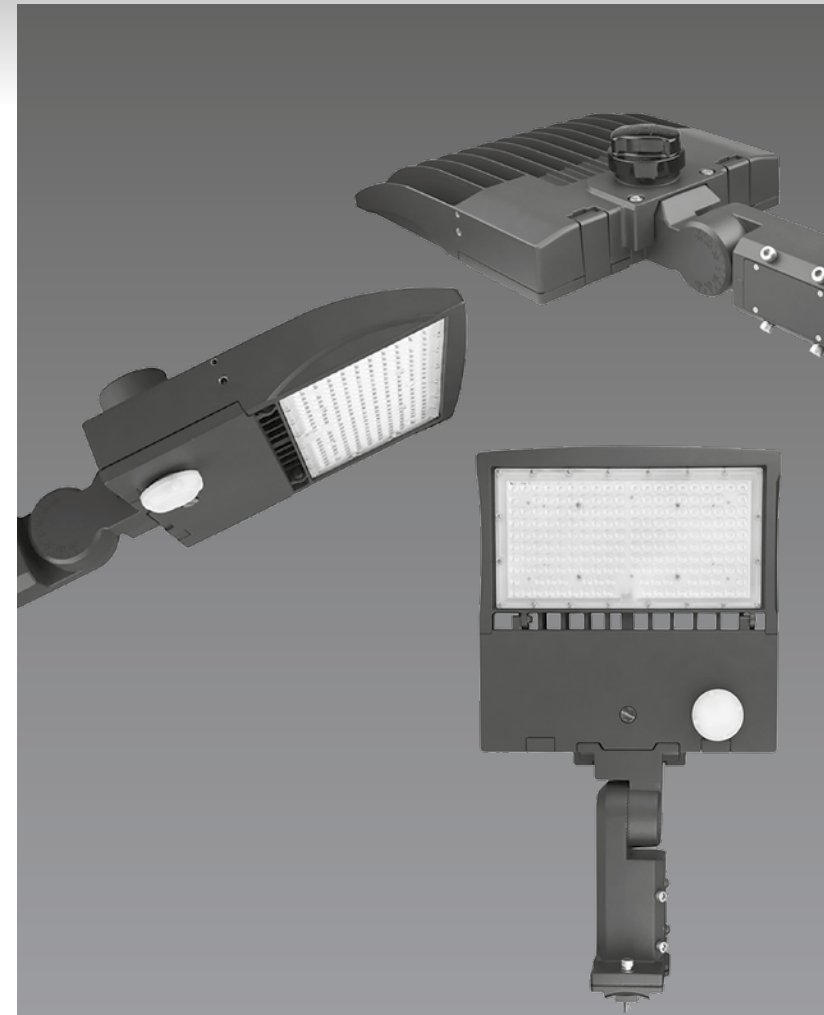

### Shoe Box Fixture Details

Product Number	Watts (Selectable)	CCT (K)	CRI (Lm/W)	Efficacy (Lm/W)	Lumen Output (Lm)	Operating temperatures		IP Rating	DLC Product ID
						Without sensor	With Sensor		
IX-SBLX-60-50L0	40/50/60	5000	>70	140	5,600 /7,000 /8,400	-58°F to 122°F	-31°F to 122°F	IP65	TBA
IX-SBLX-150-50L0	100/120/150	5000	>80	140	14,000 /16,800 /21,000	-58°F to 122°F	-31°F to 122°F	IP65	S-9SF3GD
IX-SBLX-300-50L0	200/240/300	5000	>80	140	28,000/33,600/ 42,000	-58°F to 122°F	-31°F to 122°F	IP65	S-XKPW40



# COMET

## LED SHOEBOX (AREA LUMINAIRE)

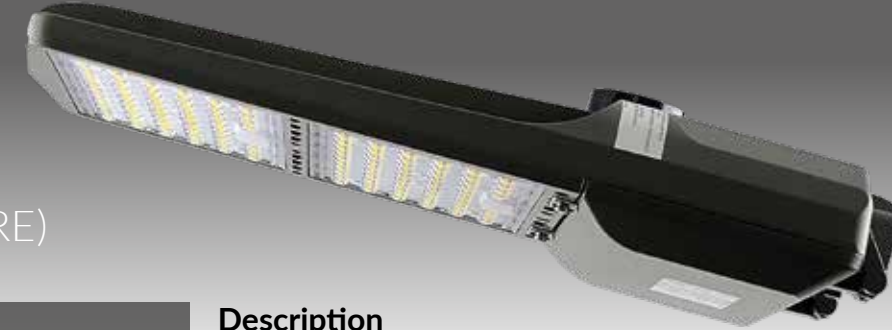

### Description

The Intrinsic COMET combines the duo of architectural form and versatility to make it an excellent choice for new construction or for retro-fit applications. It is offered in a variety of wattages (100/150/185/240/300) allowing for maximum flexibility in all types of applications.

The high output LEDs and custom engineered optics provide excellent uniformity and efficiency. It is designed to replace the existing HID fixtures up to 1000W.

### Specifications

- Temperature: 5,000K
- Dimming: Optional
- Voltage: 100 to 277V, 50 to 60Hz
- Efficacy: 130Lm/W
- Operating Temp: -40°F to 131°F
- IP Rating: IP66
- Power Factor: >0.95
- DLC Listing: Premium
- Mounting: Slip fitter, trunnion & wall mount
- Warranty: 50,000 Hours/5 Years



### Shoobox Fixture Details

Product Number	Watts (W)	CCT (K)	CRI	Efficacy (Lm/W)	Lumen Output (Lm)	Operating Temperature	Sensor Base	IP Rating	DLC Product ID
IX-SBL-150-50L0	150	5000	70	130	22,500	-40° F to 131° F	Photocell/Shorting Cap	IP66	S-3Z207G
IX-SBL-185-50L0	185	5000	70	130	26,825	-40° F to 131° F	Photocell/Shorting Cap	IP66	S-0JKD86
IX-SBL-240-50L0	240	5000	70	130	36,000	-40° F to 131° F	Photocell/Shorting Cap	IP66	S-1RHXVL
IX-SBL-300-50L0	300	5000	70	130	45,000	-40° F to 131° F	Photocell/Shorting Cap	IP66	S-4FP68M
IX-SBLZ-150-50L0	150	5000	70	130	22,500	-40° F to 131° F	Zhaga Base	IP66	S-3Z207G
IX-SBLZ-185-50L0	185	5000	70	130	26,825	-40° F to 131° F	Zhaga Base	IP66	S-0JKD86
IX-SBLZ-240-50L0	240	5000	70	130	36,000	-40° F to 131° F	Zhaga Base	IP66	S-1RHXVL

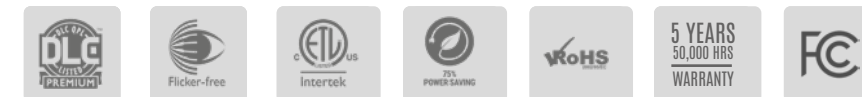

# COMET MINI

LED FLOODLIGHT



## Description

The IntrinsicX COMET Mini LED Floodlight is the best in its class for power efficiency when it comes to security. They are great for a range of commercial applications including Factory floor, libraries, public parks, train stations and any other outdoor areas in need of adequate lighting.

The Knuckle mount with an optional Trunnion mount the possibilities are endless.

With the use of the IntrinsicX COMET Mini LED Floodlights, you get the incredible power of LED lights combined with the sturdy construction needed for outdoor lighting.

## Specifications

- Voltage: 100 to 277V, 50 to 60Hz
- Operating Temp: -4°F to 113°F
- IP Rating: IP65
- Power Factor: >0.90
- DLC Listing: Premium
- Warranty: 50,000 Hours/5 years

## Fixture Details

Product Number	Power (W)	CCT(K) Optional	Trunnion Mount Optional	CRI Lm/W	Lumen Output (Lm)	Operating Temperature	IP Rating
DL-FL06-15W-50LO-KM	15	5000K	DL-MFL-TM	80+	1730Lm	-4°F to 113°F	IP65
DL-FL06-30W-50LO-KM	20	5000K	DL-MFL-TM	80+	3750Lm	-4°F to 113°F	IP65
DL-FL06-30W-30/40/50LO-KM	30	5000K Selectable	DL-MFL-TM	80+	3750Lm	-4°F to 113°F	IP65
DL-FL06-50W-50LO-KM	50	5000K	DL-MFL-TM	80+	6250Lm	-4°F to 113°F	IP65

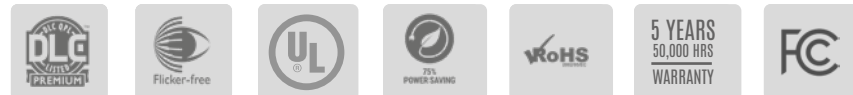

# COMET MINI GEN 2

LED FLOODLIGHT



## Description

The IntrinsicX Comet Mini Gen 2 combines the duo of architectural form and versatility to make it an excellent choice for new construction or for retro-fit applications. It is offered in a variety of wattages (15/35/60/120) allowing for maximum flexibility in all types of applications.

The high output LEDs and custom engineered optics provide excellent uniformity and efficiency.

## Specifications

- CCT: 3,000/4,000/5,000K Selectable
- Dimming: 0-10V
- Voltage: 120 to 277V, 50 to 60Hz
- Operating Temp: -22°F to 122°F
- IP Rating: IP65
- Power Factor: >0.90
- DLC Listing: Premium
- Warranty: 50,000 Hours/5 years

## Fixture Details

Product Number	Watts (W)	Voltage (V)	CCT (K)	CRI	Efficacy (Lm/W)	Lumen Output (Lm)	Operating Temperature	IP Rating	DLC Product ID
IX-MFL-15S-30/40/50LO	15	120-277	3000/4000/5000	>80	125/140/135	1875/2100/2025	-22°F to 122°F	IP65	TBA
IX-MFL-35S-30/40/50LO	35	120-277	3000/4000/5000	>80	125/140/135	4375/4900/4725	-22°F to 122°F	IP65	TBA
IX-MFL-60S-30/40/50LO	60	277-480	3000/4000/5000	>80	125/140/135	7500/8400/8100	-22°F to 122°F	IP65	TBA
IX-MFL-120S-30/40/50LO	120	120-277	3000/4000/5000	>80	125/140/135	15000/16800/16200	-22°F to 122°F	IP65	TBA

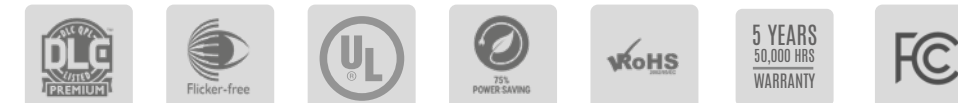

# IX-SENSORS

## NETWORK LIGHTING CONTROLS



### Description

#### Sensors

Low voltage high bay sensors are ideal for Luminaire Level Lighting Control (LLLC/NLC5) applications.

Featuring integrated daylight harvesting and PIR motion sensors, the sensors are designed for pre-installation in linear high bay or UFO high bay luminaires. IX-sensors are equipped with the AlgoH algorithm to maximize detection for high bay applications up to 40ft without false triggers.

#### Nodes

The nodes are a great solution and cost savings. Instead of having to install sensors for every fixture you can install the nodes and link up multiple fixtures off of one sensor.

#### Specifications

Dimming: 0-10v  
Voltage: 12V  
Warranty: 5 years

### Sensor details

Product Number	Input/Output Voltage (DC)	Input/Output Max Current (mA)	Input/Output Power (W)	Dimming (V)	Operating Temp.	Location & type	IP Rating	Bluetooth Transmit (Max)
IX-NLCZ10-PIR-I	12/10	50 /10	0.6W/ 0.1	0-10	-22°F to 131°F	Indoor Sensor	IP40	100'
IX-NLCZ10-NOD-I	12/10	41 /10	0.5W/ 0.1	0-10	-22°F to 149°F	Indoor Node	IP40	100'
IX-ONLCZ10-PIRPH-O	12/10	50 /10	0.6W/ 0.1	0-10	-22°F to 131°F	Outdoor Sensor	IP66	328'
IX-NLCZ10-NOD-O	12/10	41 /10	0.5W/ 0.1	0-10	-22°F to 149°F	Outdoor Node	IP66	328'
IX-NLCAUX-PIRPH-O	12/10	50 /10	0.6W/ 0.1	0-10	-22°F to 131°F	Outdoor Sensor	IP66	328'
IX-NLCAUX-NOD-O	12/10	41 /10	0.6W/ 0.1	0-10	-22°F to 149°F	Outdoor Node	IP66	328'

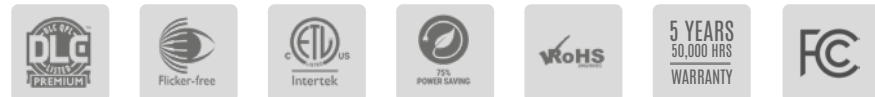

# PIR SENSORS

## KNOCKOUT SENSORS



### Description

Side Mount PIR Sensor can be mounted into a 1/2" knockout on most indoor lighting fixtures and offers multi-level control based on motion and daylight contribution.

Most commonly used in indoor high bay lighting applications.

#### Specifications

- Detection Zone: Maximum coverage 60' dia. from 8-50' height / 360°
- Voltage: 120V-277V 50/60Hz
- Mounting Height: 8'-50'
- Operating Temp: -40°F to 167°F
- UL listing: UL773A
- \* Emergency Back up: Yes (Battery)
- Warranty: 50,000 Hours/5 Years

### Fixture Details

Product Number	Type	Bluetooth Enabled	Bluetooth Transmission	Maximum Coverage	Mounting Height	Operating Temperature
IX-HB-BIP1R-1/2KO	High Bay	No	N/A	60' (8-20' height @ 360°)	8'-50'	-40°F- 167°F
IX-PIRBLE-KO	High Bay	Yes	Up to 200'	40 - 80'	8'50'	-22°F- 131°F



# EM DRIVER

## EMERGENCY BATTERY BACKUP

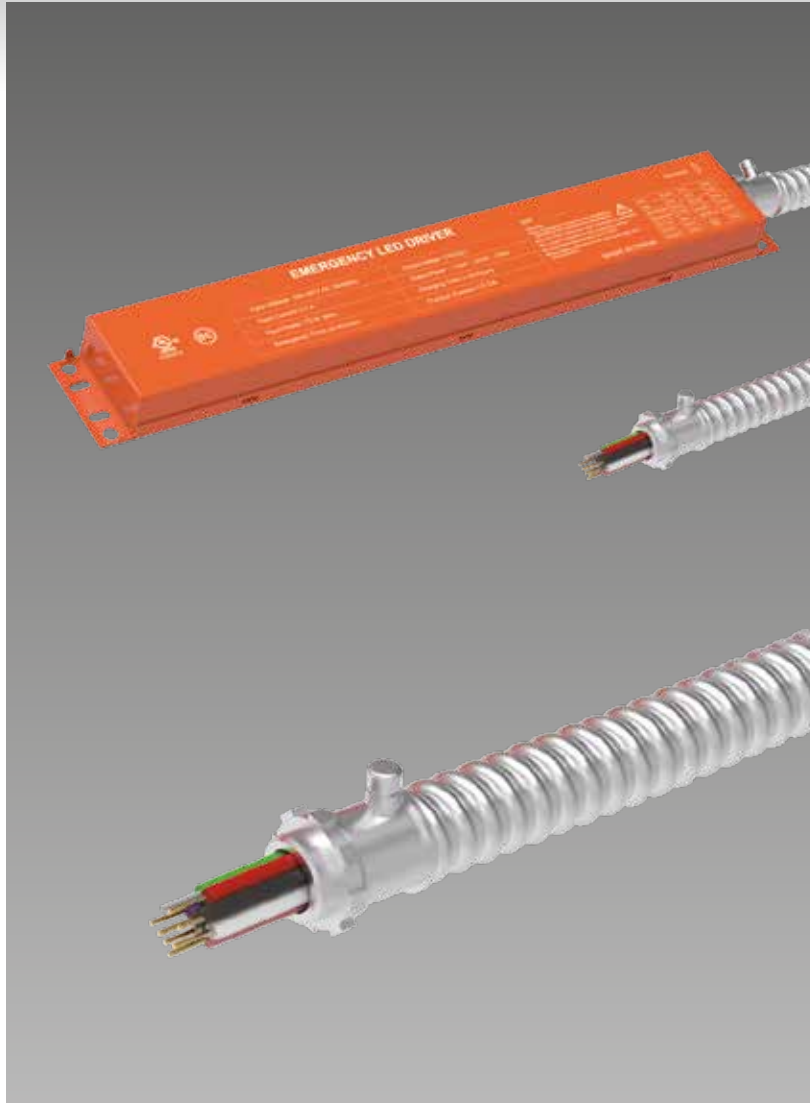

### Description

The IntrinsicX Battery Backup option is designed with a universal application in mind.

With options at 8, 15, and 25W many popular applications are covered.

This driver is line side only and can be configured with any application where the fixture or box has a 1/2" knockout.

### Specifications

- Output Power: 8W, 15W and 25W
- Dimming: 0-10V
- Voltage: 100-347VAC, 50/60Hz
- Operating Temp: 41°F to 122°F
- Warranty: 5 Years

### Emergency Backup Fixture Details

Product Number	Input Voltage (V)	Input Current max (A)	Input Power max (W)	Output Voltage (V)	Output Power (W)	Ambient Temperature	Dimming (V)
IX-EBB-HM08-YYY	100-347	0.1	12	170	8	41°F to 122°F	0-10
IX-EBB-HM15D-YYY	100-347	0.1	12	170	15	41°F to 122°F	0-10
IX-EBB-HM25D-YYY	100-347	0.1	12	170	25	41°F to 122°F	0-10



# XONE

## BLUETOOTH CONTROL APP

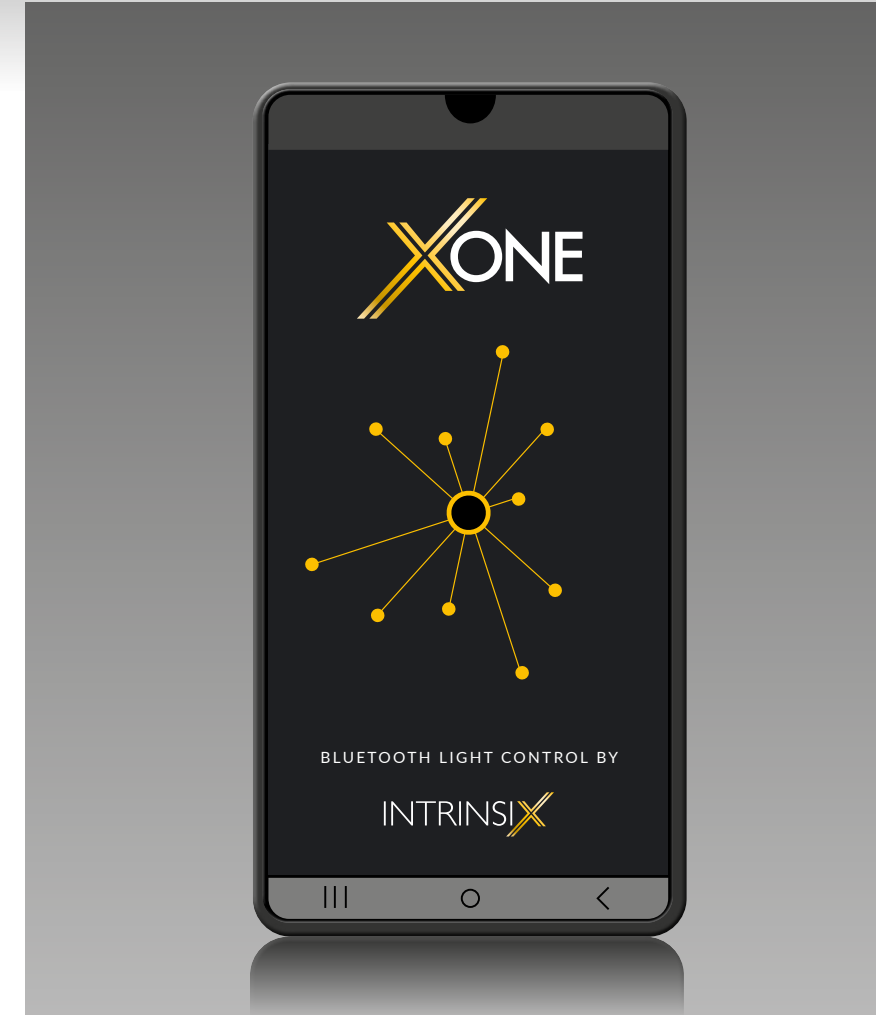

### Xone Bluetooth Control App

The IntrinsicX Xone Application sounds like a game-changer for managing lighting fixtures efficiently and conveniently.

With its ability to connect and control devices via a Bluetooth mesh network, it offers flexibility and ease of use. The feature set, including daylight harvesting, high end trimming, occupancy sensing, and scheduling, empowers users to optimize energy usage and tailor settings to their specific needs.

The app's capability to save device configurations for troubleshooting and maximizing energy savings is particularly impressive. This not only streamlines maintenance but also ensures that users can swiftly address any issues that arise.

Overall, the IntrinsicX Xone Application appears to be a versatile tool that simplifies the management of IntrinsicX ALC Devices, offering both practicality and energy efficiency benefits.



# HINTS & TIPS

## Mounting

### 80/100/150W

Power	Equivalent (MH)	Height of Installation	Coverage	Center E (FC)
80W	150W MH	8-15	Dia 24-45	20-70
100W	250W MH	9-17	Dia 27-51	20-70
150W	400W MH	11-20	Dia 33-63	20-70

Recommended installation height 8-20FT

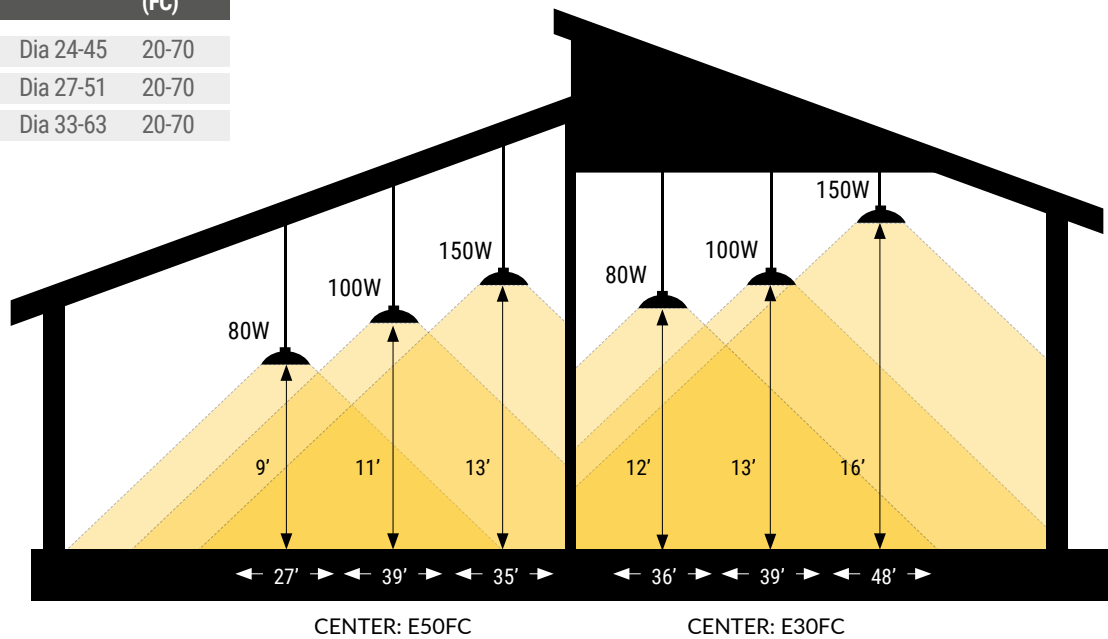

### 150/200/250W

Power	Equivalent	Height of Installation	Coverage	Center E(FC)
150W	400/600W MH	12-22	Dia 35-66	20-70
200W	400-600W MH	12-23	Dia 38-69	20-70
250W	600-1000W MH	14-25	Dia 42-75	20-70

Recommended installation height 12-25FT

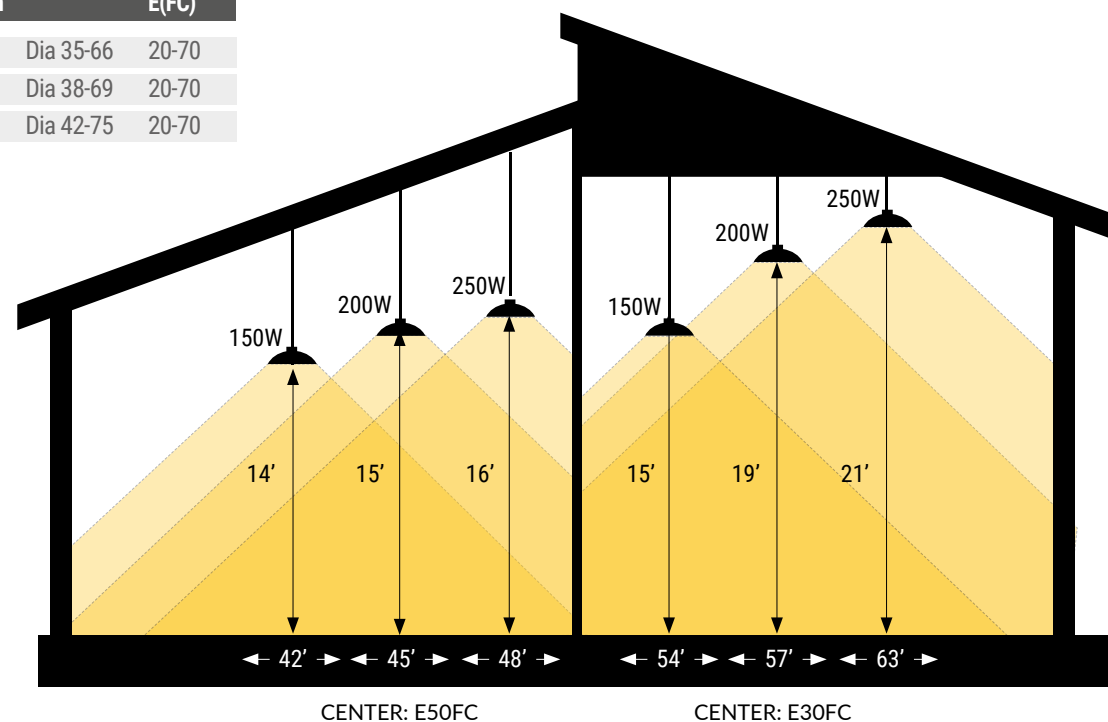

## Energy saving comparison chart

Incandescent	CFL	Metal Halide or High Pressure Sodium (HPS)	Lumens Needed	LED equivalent Levels of LED	Energy saving over Metal Halide
250	65	100	4,000	30-40W	70%
300	80	125	4,800	40W	70%
400	100	150	6,000	50-60W	70%
450	125	175	7,000	60W	70%
500	150	250	8,000	75-80W	70%
600	175	320	10,000	100W	70%
1000	300	400	16,000	120-150W	70%
2000	500	750	30,000	240-300W	70%
NA	NA	1,000	40,000	450W	70%
NA	NA	1,500	60,000	450W	70%
NA	NA	2,000	80,000	450W	70%

You can choose to go brighter if you need more light. For bulbs, just ensure you have the room for fitment and cooling. Metal Halide and HPS boxes often state 2-3 times our lumens listed here. That is because Metal Halides degredate or lose their lumens fast and dramatically- usually 70% light loss over their lifetime. and usually 30% in the first 1,000 hours.

# Thank you

for choosing IntrinsiX as your preferred lighting provider.

For further information, advice or to place an order:



224-353-4084



sales@intrinsixlighting.com



www.intrinsixlighting.com

The power of light  
made easy



[www.intrinsixlighting.com](http://www.intrinsixlighting.com)



224-353-4084



[sales@intrinsixlighting.com](mailto:sales@intrinsixlighting.com)



550 Albion Avenue, Schaumburg IL60193



Reach out to Intrinsix to talk to  
a friendly representative today by calling

**224-353-4084**

INTRINSIX